

# AUFBAUANLEITUNG KOMPOSTER „MonAmi®“

- ⓐ Assembly manual for Composter “MonAmi®“
- ⓑ Notice de montage du Composteur “MonAmi®“
- ⓓ Opbouwbeschrijving voor CompostBox “MonAmi®“
- ⓔ Instrucciones de montaje de Compost “MonAmi®“
- ⓖ Istruzioni di montaggio Compostiera “MonAmi®“
- ⓓk Monteringsvejledning for Kompostbeholder “MonAmi®“

For further languages please go to: [www.biohort.com/downloads](http://www.biohort.com/downloads)



# WICHTIGE PUNKTE FÜR DEN AUFBAU!

## VORLIEGENDE AUFBAUANLEITUNG ZEIGT DEN ZUSAMMENBAU FÜR EINEN KOMPOSTER „MONAMI“. FÜR EINIGE MONTAGESCHRITTE BENÖTIGEN SIE EINEN HELFER.

- GB** Important details regarding assembly! The available assembly manual shows the installation of the composter "MonAmi". For several assembly steps additional assistance of one person will be required.
- FR** Points importants lors du montage! „Cette notice de montage décrit l'assemblage du composteur "MonAmi". Pour certaines étapes, demandez l'aide d'une ou deux personnes.
- NL** Deze opbouwbeschrijving toont de opbouw van de compostbak "MonAmi". Bij enkele stappen tijdens de opbouw heeft u een 2e persoon nodig.
- ES** Notas importantes para el montaje: Estas instrucciones de montaje muestran el ensamblaje de un compostador "MonAmi". Es recomendable realizar el montaje entre dos personas.
- IT** La presente istruzione di montaggio dimostra il montaggio di una compostiera "MonAmi". Per alcune fasi di assemblaggio vi servirà qualche aiutante.
- DK** Denne vejledning viser samling af kompostbeholder "MonAmi". Ved flere punkter af opsætningen er yderligere hjælp påkrævet af 1 eller 2 personer.

## VERWENDEN SIE BEI DER MONTAGE ARBEITSHANDSCHUHE! UM KRATZER ZU VERMEIDEN, VERWENDEN SIE BITTE GEEIGNETE UNTERLAGEN!

- GB** Wear working gloves! Please use a suitable underlay to avoid scratches!
- FR** Portez des gants de travail! Pour éviter les rayures, utilisez les supports appropriés!
- NL** Handschoenen gebruiken! Om krassen te voorkomen raden wij u aan er iets onder te leggen!
- ES** Utilice unos guantes de trabajo. Por favor, coloque en el suelo una base protectora adecuada para evitar posibles arañazos.
- IT** Utilizzare guanti da lavoro. Utilizzare una base adatta per evitare graffi!
- DK** Brug arbejdshandsker! Benyt venligst et passende underlag for at undgå skrammer!

## ACHTEN SIE AUF EINE STURMSICHERE BODENVERANKERUNG UND VERRIEGELN SIE DEN DECKEL! NICHT BEI WIND AUFBAUEN!

- GB** Please make sure the product is anchored in a storm-proof manner and lock the lid! Do not assembly in windy condition!
- FR** Veillez à ce que le sol soit ancré de manière à résister aux tempêtes et verrouillez les couvercles ! Ne pas procéder au montage dans des conditions venteuses !
- NL** Zorg voor een stormbestendige bodem verankering en vergrendel de dekse! Niet opbouwen in winderige omstandigheden!
- ES** Asegúrese de que el suelo cuente con un anclaje a prueba de tormentas y cierre las tapas. ¡No se instalen en condiciones de viento!
- IT** Assicuratevi che il pavimento sia ancorato a prova di tempesta e chiudete a chiave le coperchio! Non montare in condizioni di vento!
- DK** Vær opmærksom på at produktet forankres stormsikkert samt at låg er aflåst! Bør ikke monteres ved kraftig vind!



## HALTEN SIE WÄHREND DES ZUSAMMENBAUS ALLE MITGELIEFERTEN KLEINTEILE ODER VERPACKUNGSMATERIALIEN FERN VON KLEINKINDERN.

Bauteile weisen scharfe Kanten auf oder stehen vor, achten Sie während der Montage und bei der täglichen Nutzung darauf.

- GB** Keep all supplied small parts or packaging materials away from small children during assembly. Components have sharp edges or protrude, pay attention to them during assembly and during daily use.
- FR** Gardez toutes les petites pièces ou les matériaux d'emballage fournis hors de portée des enfants pendant le montage. Les pièces d'assemblage peuvent être tranchantes, faites-y attention lors de l'assemblage et de l'utilisation quotidienne.
- NL** Houd alle kleine onderdelen of verpakkingsmaterialen die worden mee geleverd uit de buurt van kleine kinderen tijdens de montage. Onderdelen hebben scherpe randen of steken uit, let op bij de montage en bij het dagelijks gebruik.
- ES** Mantenga todas las piezas pequeñas o materiales de embalaje suministrados lejos de los niños durante el montaje. Los componentes tienen bordes afilados o salientes, preste atención a ellos durante el montaje y durante el uso diario.
- IT** Tenere tutte le piccole parti o i materiali d'imballaggio forniti lontano dalla portata dei bambini durante il montaggio. I componenti hanno spigoli vivi o sporgenti, prestare attenzione ad essi durante il montaggio e durante l'uso quotidiano.
- DK** Hold alle leverede smådele og emballage utilgængeligt for børn under montagen. Komponenter har skarpe kanter eller stikker ud, vær opmærksom på dem under monteringen og under daglig brug.

## ACHTUNG: IM SOMMER KÖNNEN IM INNENRAUM SEHR HOHE TEMPERATUREN ENTSTEHEN!

- GB** Attention: during the summer high temperature might arise in the interior.
- FR** Attention: En été la température à l'intérieur de l'abri peut être élevée!
- NL** Let op: in de zomer kunnen in de berging zeer hoge temperaturen bereikt worden.
- ES** Tenga en cuenta que en el verano las temperaturas en el interior pueden ser altas.
- IT** I dadi devono essere serrati a fondo soltanto alla fine del montaggio!
- DK** Attention: Si prega di prendere nota che in estate si possono essere temperature molto elevate all'interno.

## PFLEGE UND WARTUNG

**Keine aggressiven Chemikalien wie z.B. Chlor oder Streusalz lagern! Sonnenmilch und andere Cremen mit Wasser und Seife entfernen! Keine scheuernden Reinigungsmittel verwenden!**

- GB** Care and maintenance: Do not store aggressive substances i.e. chlorine or road salt! Remove suntan lotion or any other creams with water and rinse aid! Do not use abrasive cleaning agents!
- FR** Entretien et maintenance: Ne pas stocker de produits chimiques (chlore, sel, etc...) Nettoyez uniquement avec de l'eau les crèmes solaires et autres crèmes (pas de nettoyant chimique).
- NL** Onderhoud: Geen chemicaliën in de berging opslaan! Zonnebrandolie/melk en andere cremes met water en zeep verwijderen! Gebruik geen schuurmiddelen!
- ES** Cuidado y mantenimiento: No almacene productos químicos agresivos dentro de la caseta como por ejemplo cloro y sal antiescarcha. Evite dejar huellas o restos de cremas solares sobre la chapa. Limpie la caseta siempre con agua o un trapo húmedo.
- IT** Manutenzione: Non lasciare prodotti chimici aggressivi (come ad esempio cloro o sale per strade) all'interno della casetta! Rimuovere crema solare e altre creme con acqua e brillantante!
- DK** Pleje og vedligeholdelse: Opbevar ikke aggressive stoffer dvs. Klor eller vejsalt! Fjern solcreme eller andre typer af creme med vand og rensningsmiddel! Brug ikke aggressive rengøringsmidler!

## MASSTABSGETREUE ABBILDUNGEN DER ZU VERWENDENDEN SCHRAUBEN: (M 1:1)

- GB** Scale drawing 1:1 of the screws in use
- FR** Reproduction selon l'échelle 1:1.
- NL** Afbeelding : schaal 1:1 (ware grootte)
- ES** Reproducción a escala 1:1 de los tornillos que se utilizan para el montaje.
- IT** Immagine in scala delle viti da utilizzare!
- DK** Skala tegning af skruer er 1:1

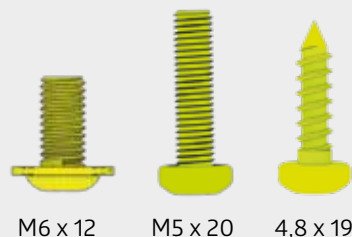

## WASSERWAAGEN - SYMBOL:

**Betreffendes Einbauteil mit der Wasserwaage ausrichten.**

- GB** Symbol of spirit level: Align the respective parts by using the spirit level..
- FR** Symbole niveau à bulle: Lorsque ce symbole apparaît, vous devez ajuster l'élément à l'aide d'un niveau à bulle.
- NL** Waterpas - symbol: Bij montage stappen waar dit symbool bijstaat is het noodzakelijk het betreffende onderdeel waterpas in te bouwen.
- ES** Símbolo del nivelador: Indica que se debe ajustar y centrar la pieza con la ayuda de un nivelador.
- IT** Simbolo di livella a bolla d'aria: Allineare il componente in questione con l'ausilio di una livella a bolla d'aria.
- DK** Symbol for vaterpas: Juster de respektive dele ved hjælp af vaterpas.

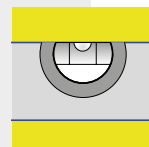

## 1 PANEEL - PAKET

Panel package · Colis de parois · Paneelpakket · Paquete de panel · Pacco pannelli · Pladepakke

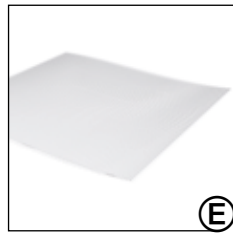
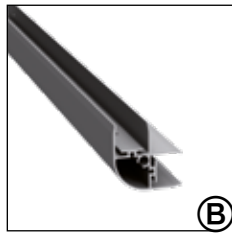
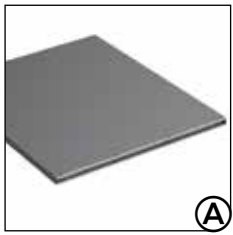

## 2 DECKEL - PAKET

Lid package · Colis du couvercle · Dekselpakket · Paquete de tapa · Pacchetto di coperchio · Dækselpakke

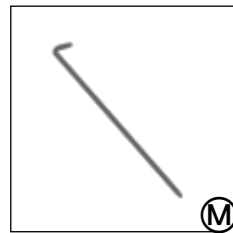
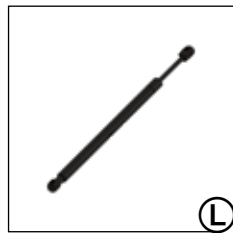
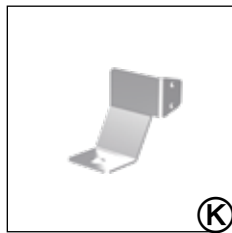
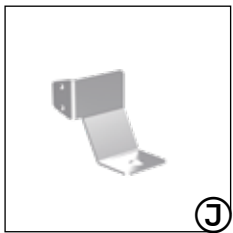
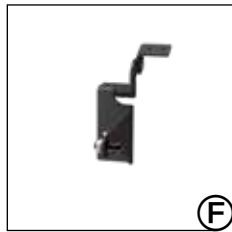



1.

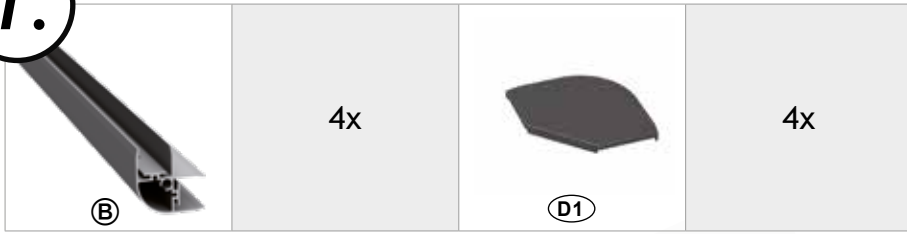

2.

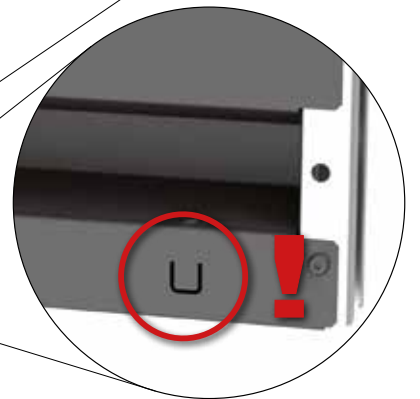
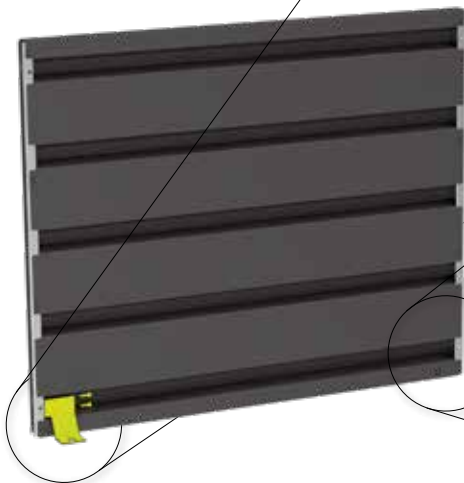

3.

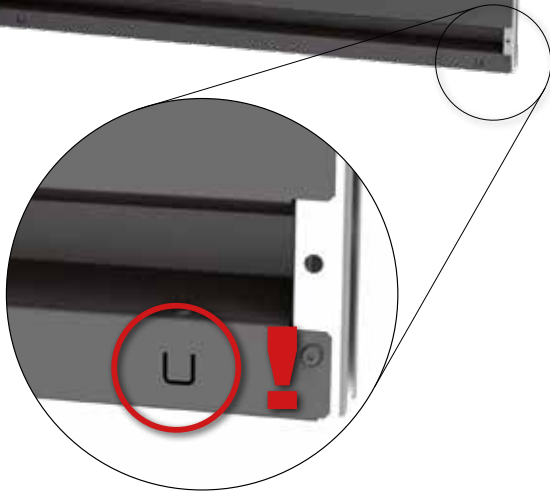
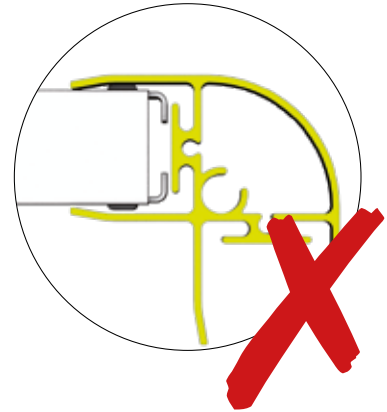
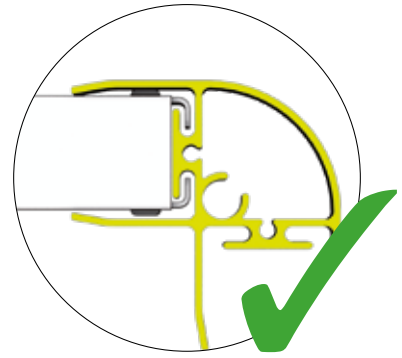
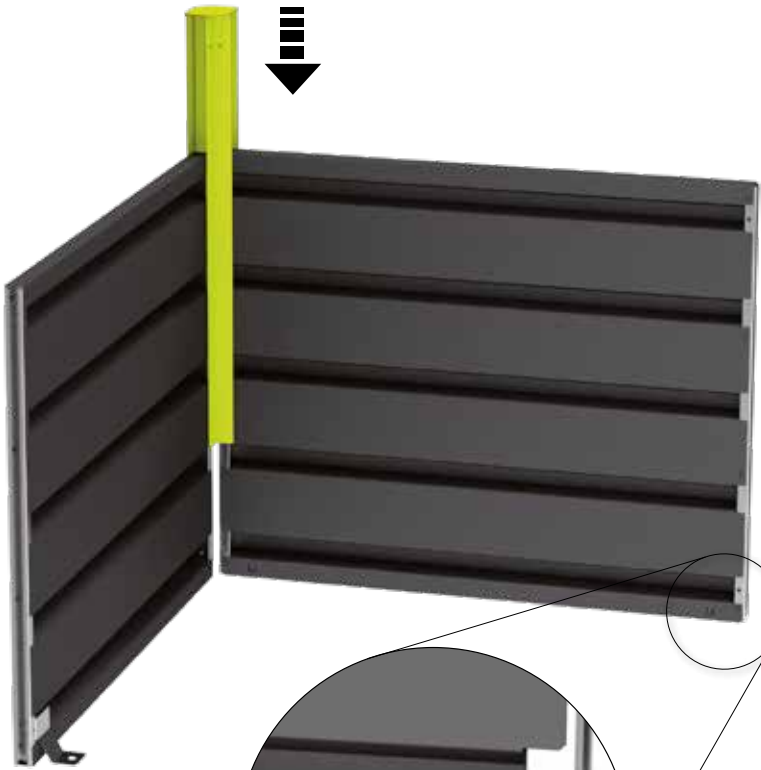
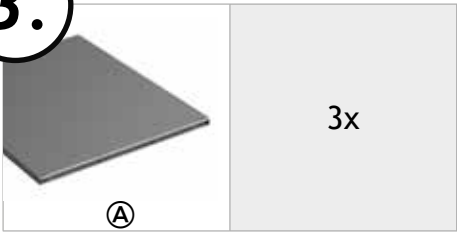

4.

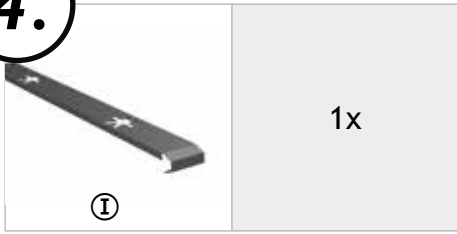

*Option:*





5.

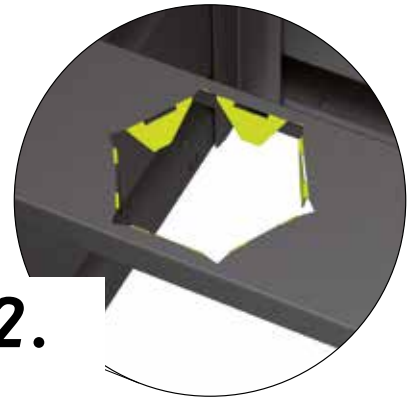
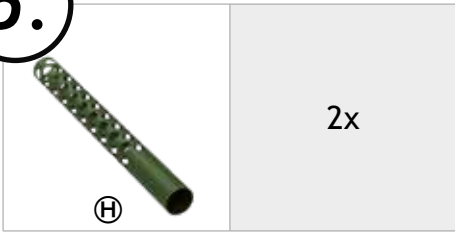

6.



1x

4,8 x 19



8x

A

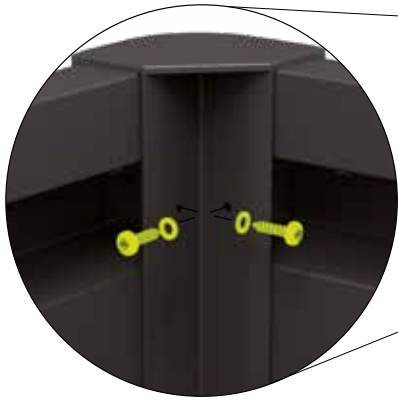

D1

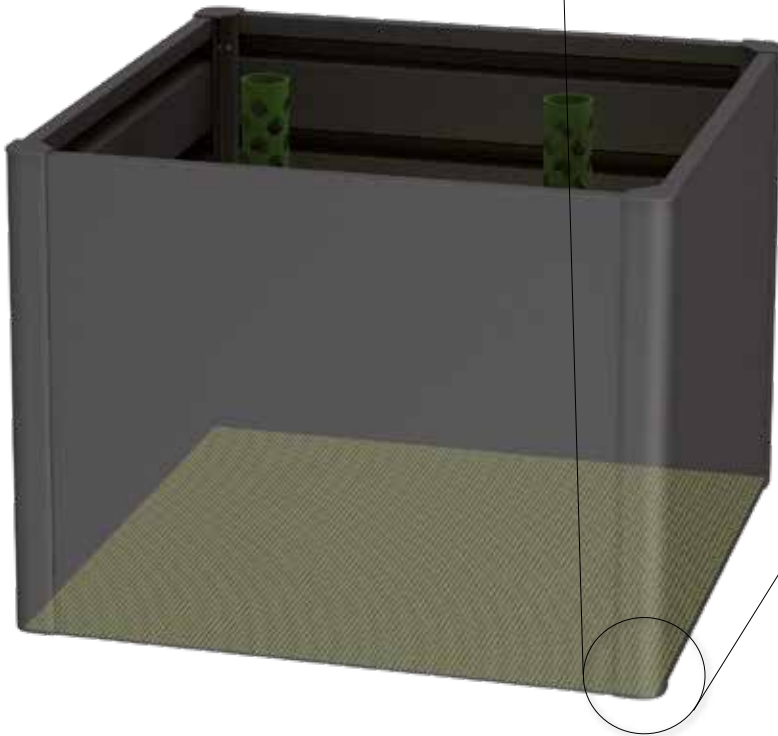
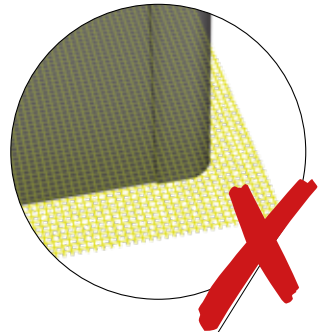
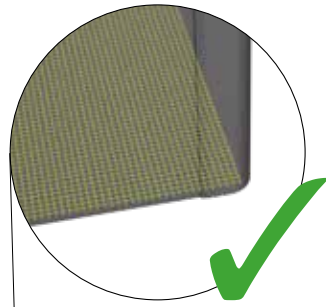
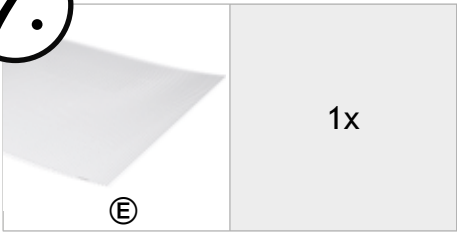

7.







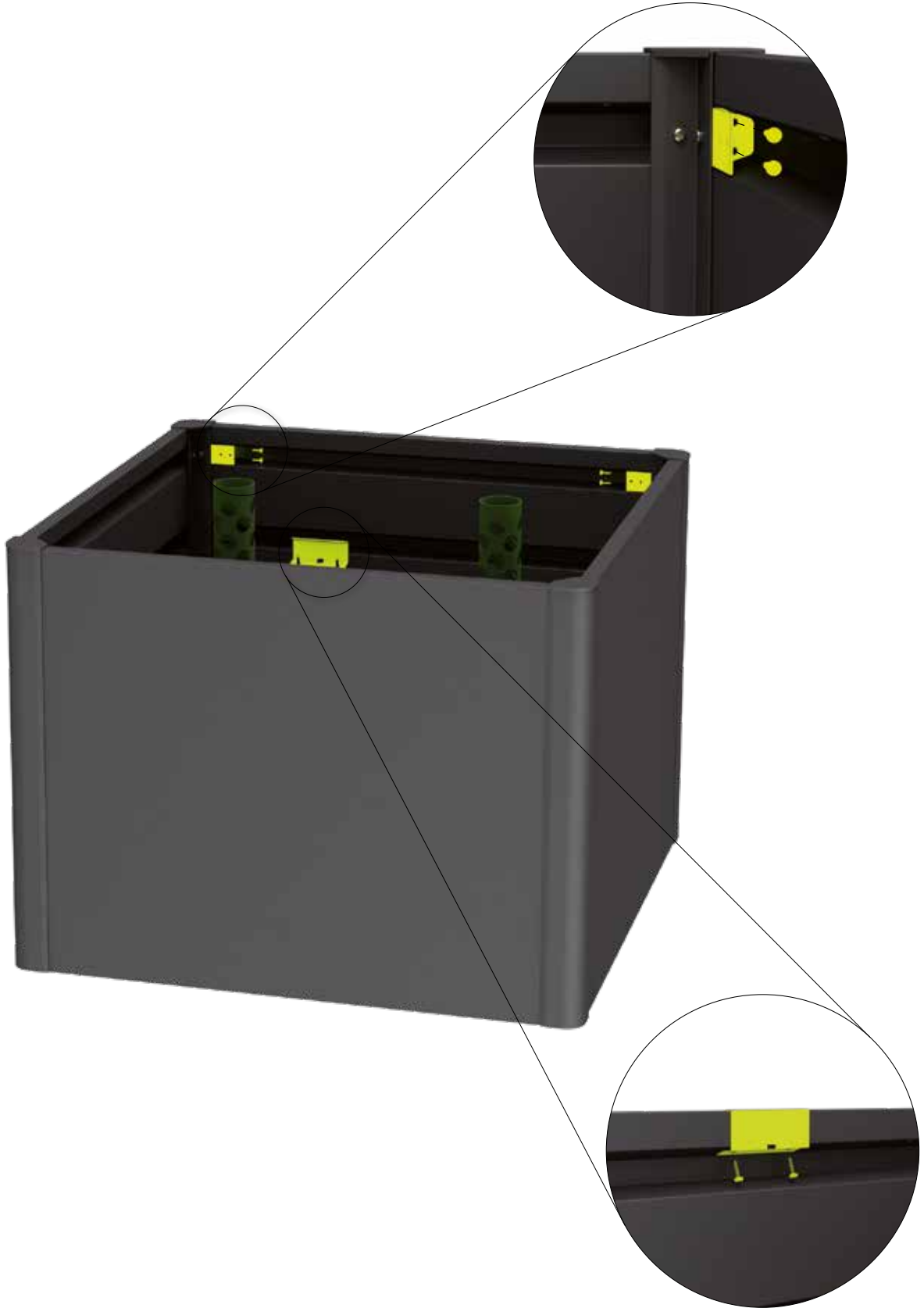



8.

|   |    |   |    |  |    |
|---|----|---|----|--|----|
| <br>D2 | 2x | 4,8 x 19<br><br>D2 | 6x | <br>N | 1x |
|---|----|---|----|--|----|



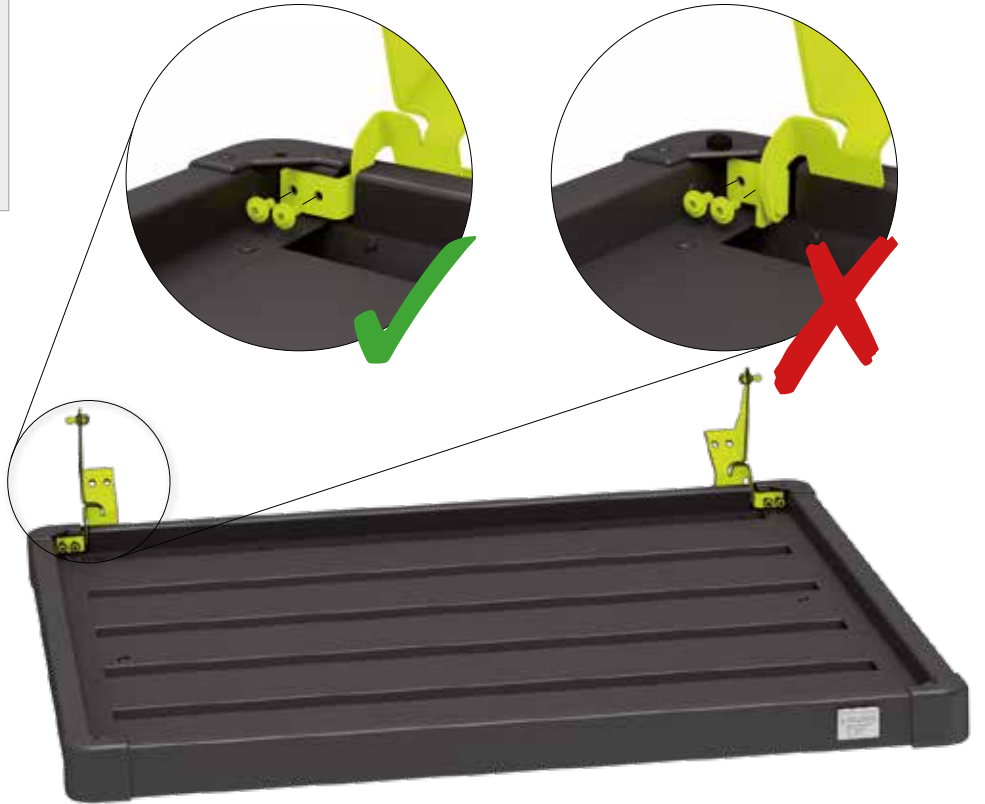

9.

|  |    |  |    |   |    |
|--|----|--|----|---|----|
|  <p>©</p>                  | 1x |  <p>Ⓕ</p> | 1x |  <p>Ⓖ</p>  | 1x |
| <p>M6 x 12</p>  <p>Ⓓ2</p> | 4x |  <p>Ⓖ</p> | 1x |  <p>Ⓓ2</p> | 2x |
| <p>M5 x 20</p>  <p>Ⓓ2</p> | 2x |          |    |   |    |



# 10.

|   |    |   |    |  |    |
|---|----|---|----|--|----|
| <br>D2 | 4x | <br>D2 | 2x | <br>L | 2x |
|---|----|---|----|--|----|

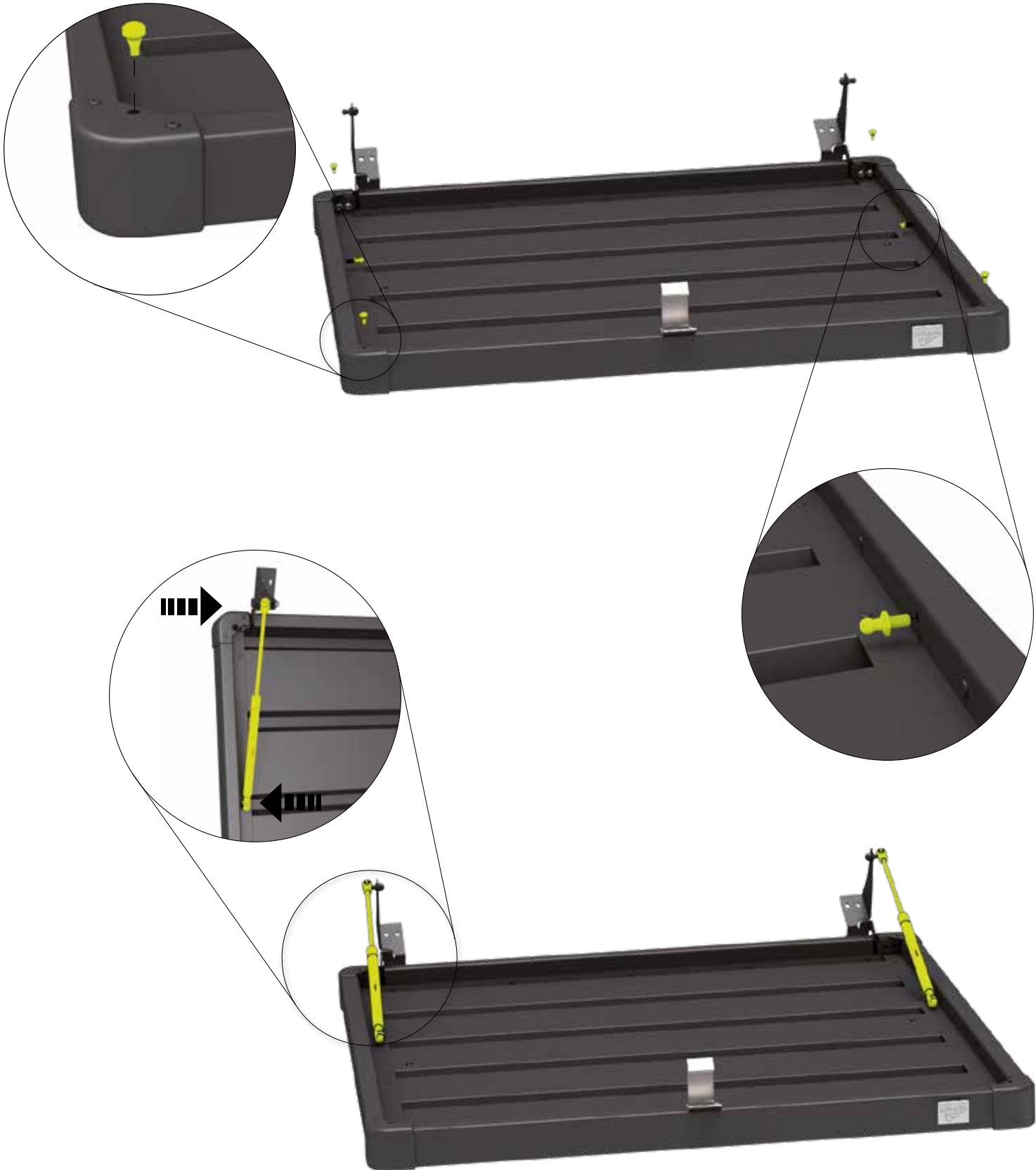

11.

M6 x 12



D2

4x



**12.**

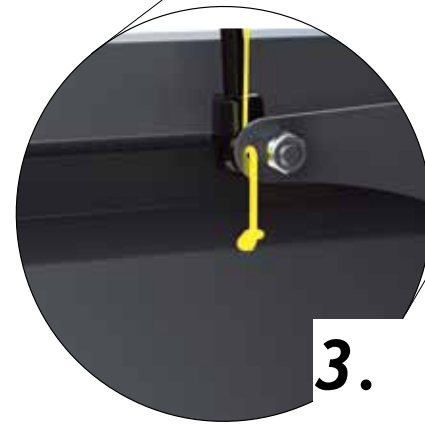
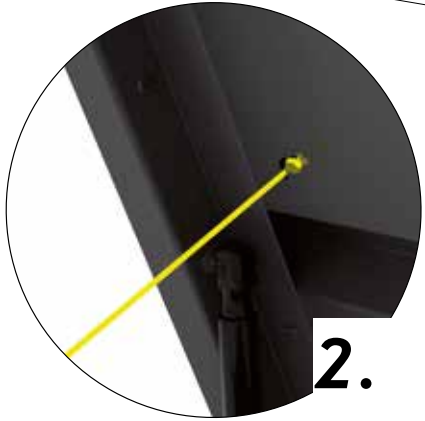
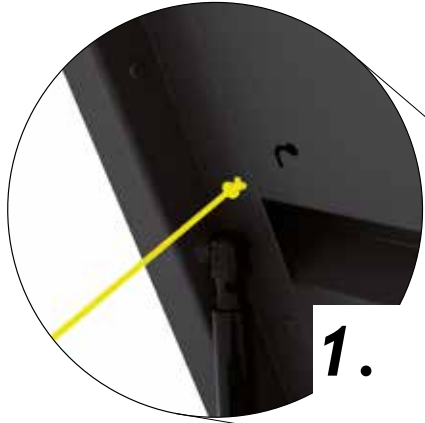
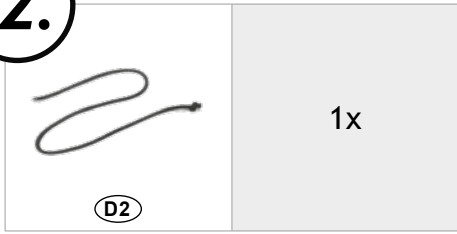



13.

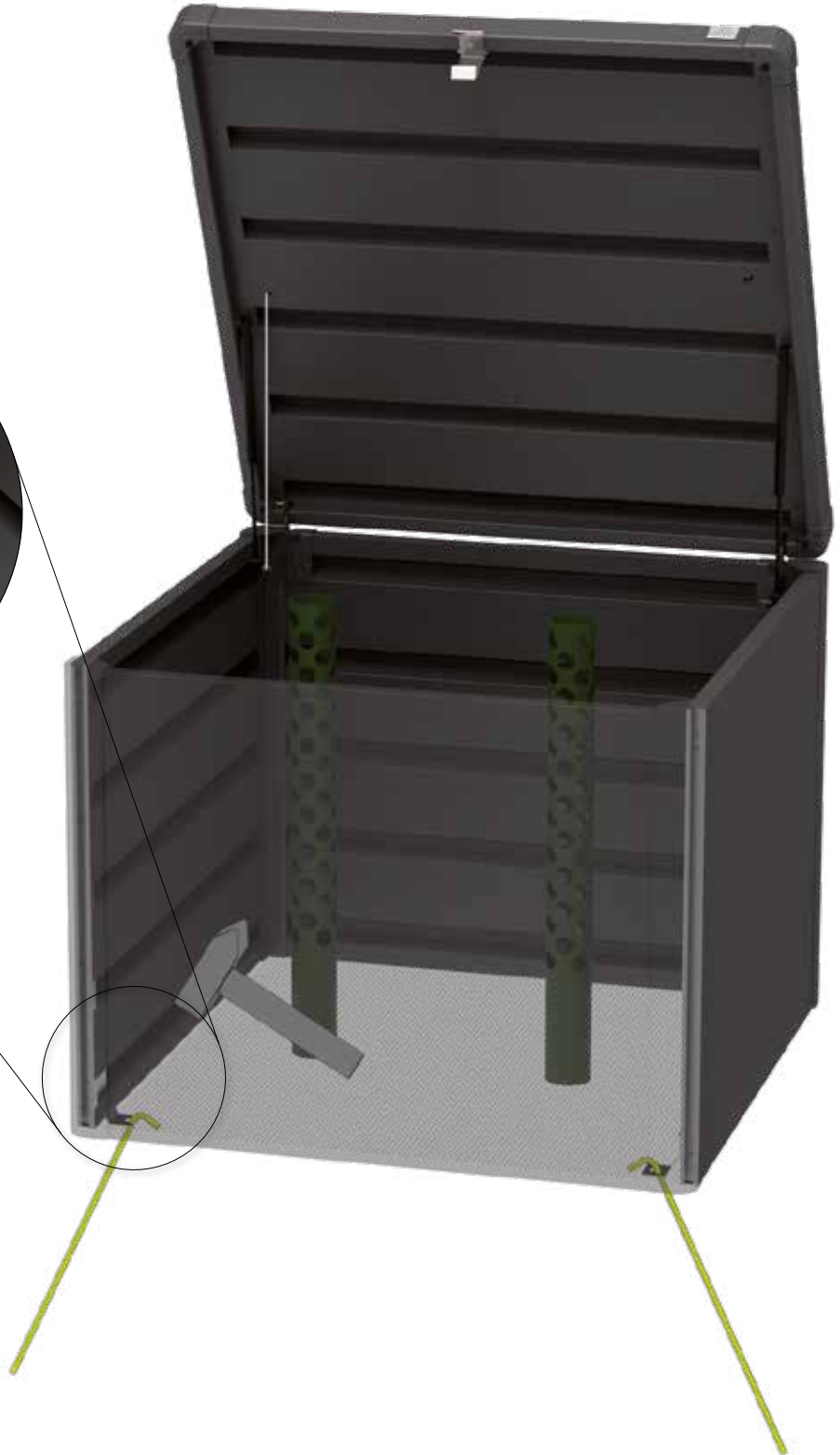
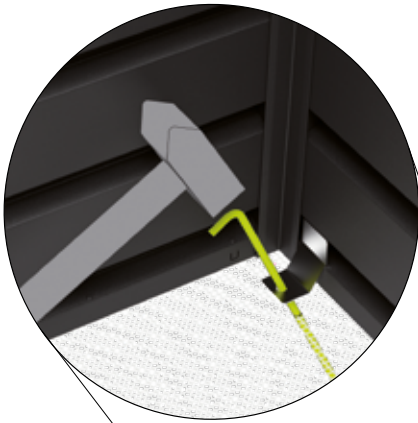
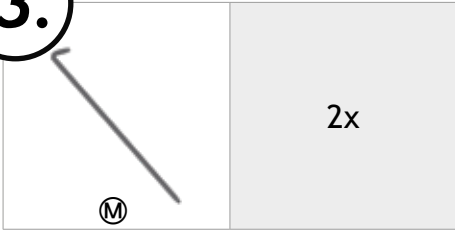







**GERÄTEHÄUSER** – Setzen Sie auf Qualität & Langlebigkeit  
**GARDEN SHEDS** – rely on quality & longevity



**GARTENBOXEN** – Outdoorboxen für Garten, Terrasse & Co.  
**OUTDOOR BOXES** – outdoor boxes for garden, patio & more



**FAHRRAD-GARAGEN** – Fahrräder, Roller & Co sicher verstaut  
**BICYCLE STORAGE** – for safe storage of bicycles, scooters & more



**MÜLLTONNEN-BOXEN** – Stylish, praktisch & wartungsfrei  
**DUSTBIN STORAGE** – stylish, practical & maintenance free



**GARTEN-HELFER** – Gartendesign in Bestform  
**GARDENING HELPERS** – garden design at its best

Kontrollnummer:  
 Control-number / Contrôle-Qualité / Controlnummer:



Bei Reklamationen bitte anführen:  
 Kontrollnummer und Artikelnummer des reklamierten Teils.

GB: In case of complaint please indicate the control-number and the number of the item, which is subject of complaint.

F: Pour toutes réclamations: prière de joindre le numéro de contrôle et le numéro d'article de la pièce litigieuse.

NL: Bij reclamaties svp doorgeven: controlnummer en artikelnummer van het desbetreffende onderdeel.



Biohort steht für  
 „LEBEN IM GARTEN“

Biohort stands for  
 „LIFE IN THE GARDEN“

follow us:

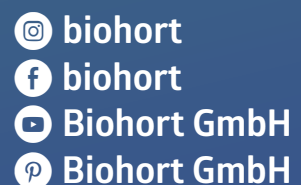

**Biohort GmbH**  
 Pürnstern 43, 4120 Neufelden, Österreich  
 Tel: +43-7282-7788-0  
 E-Mail: office@biohort.at, www.biohort.com