

Schnitt B-B

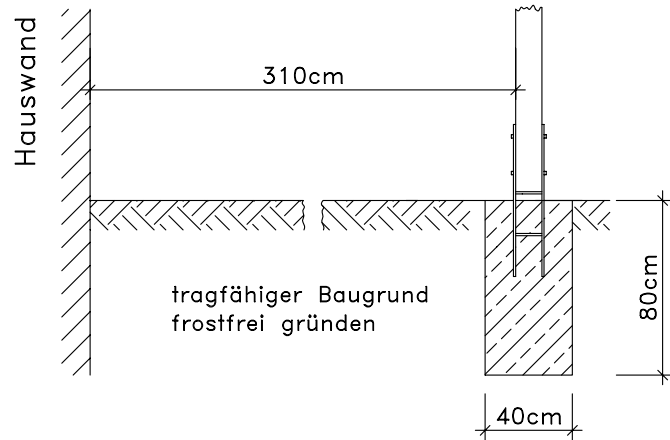

Schnitt A-A

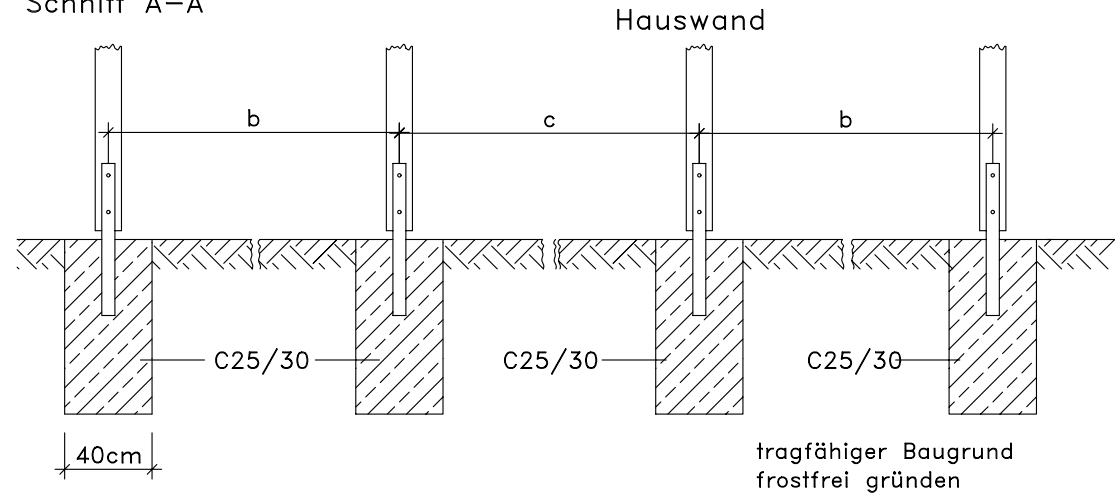

Grundriß

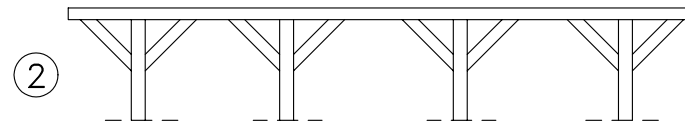
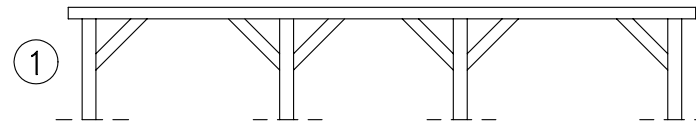
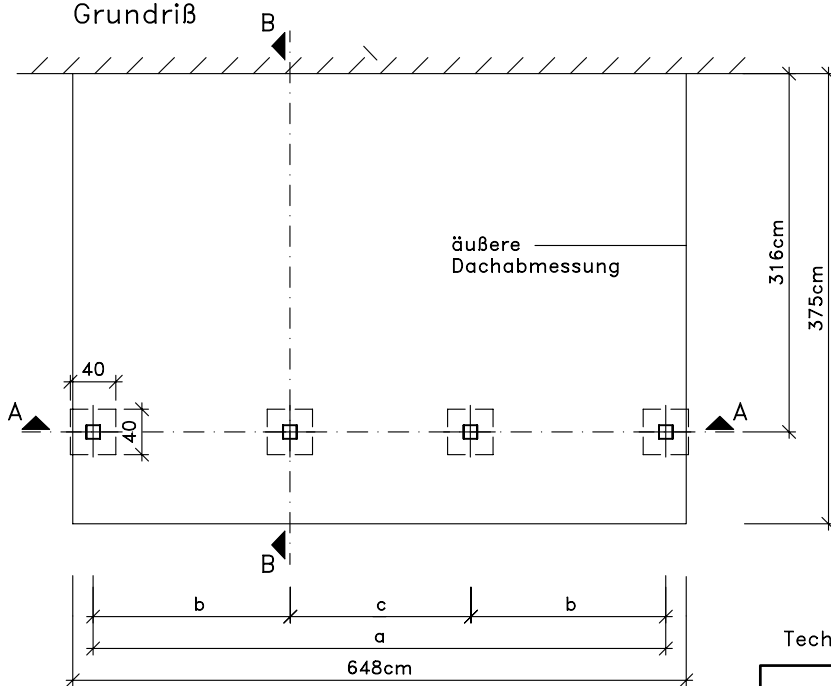

- ① a=624cm; b=215,5cm; C=193cm
- ② a=539cm; b=173cm; C=193cm

D GB F I E P CZ PL HR SLO NL H

➔ 2/2

Technische Änderungen vorbehalten! © Copyright weka-Holzbau GmbH Neubrandenburg Stand: 19.05.2009

	Datum	Unterschrift	Zeichnungsnummer	
Gezeichnet	19.05.2009	Ely	FP672-3865	
Geändert				
Blatt-Nr.:	Terrassen-Überdachungen Fundamentplan			1/2

D	GB	F	I	E	P	CZ	PL	HR	SLO	NL	H
Fundamentplan	Foundation plan	Plan de fondation	Schema delle fondamenta	plano de fundación	Plano de fundações	Výkres základů	Plan fundamentów	Nacr temelja	načrt temeljev	funderingsplan	Alapzatterv
Terrassen- überdachung	Terrace roof	Pergola	Copertura per verande	Tejado para terraza	Cobertura de terraço	Zastřešení teras	Zadaszenie tarasu	Nadstrešnica za terase	terasni nadstrešek	terrasoverkapping	Terasztető
Anlehn-Carport	Lean-to carport	Abri-garage attenant	Copertura per posto auto a muro	Cobertizo para coche adosado	Abriço anexo para automóvel	Opěrný přístřešek na auta	Wiata jako przybudówka	Prislonjena nadstrešnica za aute	naslonjen garažni nadstrešek	aanleun-carport	Megtámasztott autóbeálló
Hauswand	House wall	Mur de la maison	Parete della casa	Pared de la casa	Parece da casa	Stěna domku	Ściana domu	Kućni zid	hišna stena	huiswand	Házfal
Detail	Detail	Détail	Dettaglio	Detalle	Pormenor	Detail	Szczegóły	Detalj	podrobnost	detail	Részlet
Beton C25/30	C25/30 concrete	Béton C25/30	Calcestruzzo C25/30	Hormigón C25/30	Betão C25/30	Beton C25/30	Beton C25/30	Beton C25/30	beton C25/30	beton C25/30	Beton C25/30
tragfähiger Baugrund	load-bearing foundation	Sol de fondation stable	Sottofondo stabile	terreno firme	terreno de construção resistente à carga	únosný stavební pozemek	nošny grunt budowlany	Nosivo građevno tlo/podloga	nosilno gradbeno zemljišče	belastbare bouwgrond	Teherhordó terület
frostfrei gründen	frost-free base	Fondation hors gel	fondazione protetta dal gelo	echar cimientos con protección frente a heladas	Criar fundações com profundidade suficiente (ao abrigo do gelo)	základy v nemrzoucí hloubce	posadowić poza strefą przemarzania	Fundiranje/postavljanje temelja zaštićenog od smrzavanja	postavitev pred zmrzovanjem	fundering vorstvrij	Fagymentes alapozás
Technische Änderungen vorbehalten!	We reserve the right to make technical alterations.	Sous réserve de modifications techniques!	Ci riserviamo il diritto di apportare modifiche tecniche!	¡Salvo modificaciones técnicas!	Reservamo-nos o direito a alterações técnicas!	Technické změny vyhrazeny!	Zastrzega się możliwość wprowadzania zmian technicznych!	Zadržavamo pravo na tehničke izmjene!	Pridržujemo si pravice do tehničnih sprememb!	Technische wijzigingen voorbehouden!	A műszaki változtatások jogát fenntartjuk!

Technische Änderungen vorbehalten! © Copyright weka-Holzbau GmbH Neubrandenburg Stand: 19.05.2009

	Datum	Unterschrift	Zeichnungsnummer	 www.weka-Holzbau.com
Gezeichnet	19.05.2009	Ely	FP672-3865	
Geändert				
Datei	<div style="display: flex; justify-content: center; gap: 10px;"> D GB F I E P CZ PL HR SLO NL H </div> <p style="text-align: center;">Fundamentplan</p>			Blatt-Nr.: 2/2