

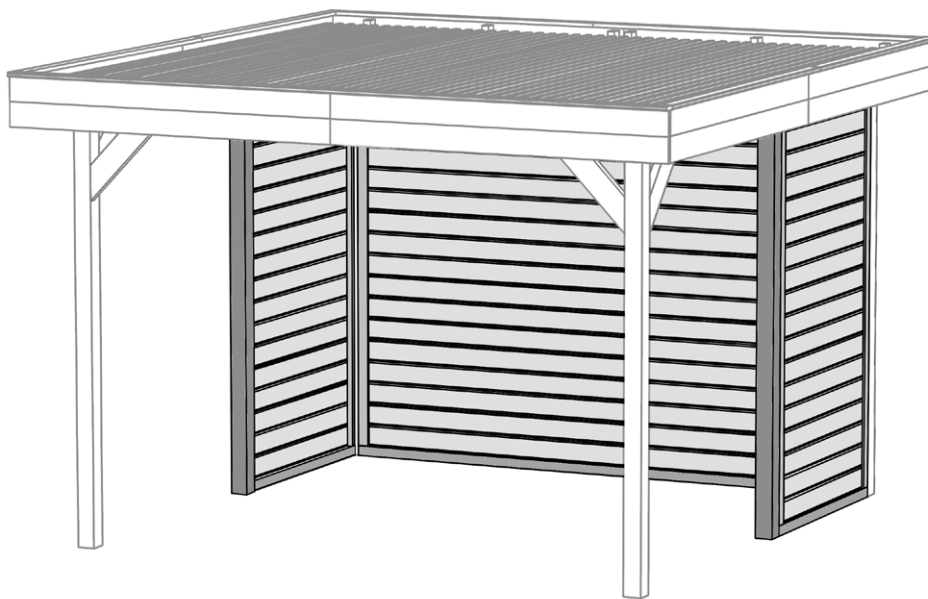

www.weka-holzbau.com

## Wandset 1



Art.-Nr.: 657.2626.09.00

Art.-Nr.: 657.3535.09.00

## Montage-, Bedienungs- und Wartungsanleitung

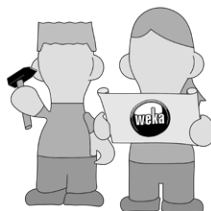

Stand: 2122

**Sehr geehrte Kundin, sehr geehrter Kunde,  
danke, daß Sie sich für ein weka – Produkt entschieden haben.**

- Lesen Sie diese Anleitung vor dem Aufbau bitte vollständig durch, um Montagefehler oder Beschädigungen zu vermeiden.
- **WICHTIG !**  
**Prüfen Sie bitte sofort anhand der Packliste, ob das weka-Produkt vollständig und unbeschädigt bei Ihnen angekommen ist.**
- Bitte vernichten Sie die Packliste erst nach Ablauf der Garantiezeit. Diese Liste dient Ihnen zur Kontrolle auf Vollständigkeit der Einzelteile und ist mit dem Kaufbeleg aufzubewahren. Eventuelle Beanstandungen können mit Hilfe dieser Liste problemlos behoben werden. Die Pos.-Nummern der Packliste stimmen nicht mit den Pos.-Nummern folgender Montageanleitung überein.
- Wir empfehlen Ihnen die Montage mit 3 Personen durchzuführen.
- Zur Verhütung von Unfällen ist zu vermeiden, daß sich Kinder während der Montage in unmittelbarer Nähe befinden.
- Weiterentwicklungen im Sinne des technischen Fortschritts behalten wir uns vor. So können geringfügige Abweichungen in den Darstellungen entstehen.
- Verpackungsmaterial nicht einfach wegwerfen! Papier-, Pappe- und Wellpappeverpackungen, so wie Kunststoffverpackungsteile sollten in die entsprechenden Sammelbehälter gegeben werden.

## **EMPFEHLUNGEN**

- **Bitte bohren Sie alle Schraubverbindungen vor, um Beschädigungen an den Holzteilen zu vermeiden! Folgendes Zeichen macht Sie während der Anleitung nochmals darauf aufmerksam:**



- Schützen Sie das Holz vor stundenlanger, direkter Sonneneinwirkung oder Feuchtigkeit.
- Holz ist ein Naturprodukt. Verschiedenartige Färbungen, Äste und Rißbildung sind normal und haben keinen Einfluß auf die Statik.

### **ACHTUNG!**

- Die Maße sind im Verlauf der gesamten Montage regelmäßig zu kontrollieren!

## **HOLZSCHUTZ**

Das Produkt besteht aus dem natürlichen Rohstoff Holz. Dies macht regelmäßig ausreichende Holzschutzmaßnahmen zwingend erforderlich. Für die fachgerechte Holzschutzbehandlung wenden Sie sich bitte an einen Holzschutzfachmann.

Holzschutzmaßnahmen sind vom Kunden in eigener Verantwortlichkeit durchzuführen. Ohne vorschriftsmäßigen Holzschutz kann keine Gewährleistung übernommen werden. Bitte beachten Sie auch die diesbezüglichen Bestimmungen in unseren Garantieerklärungen.

Wir wünschen Ihnen viel Freude mit Ihrem Holzprodukt.

## **GARANTIEBESTIMMUNGEN**

Die Firma weka Holzbau GmbH gewährt Ihnen 5 Jahre Garantie auf Konstruktion und Verarbeitungsqualität. Innerhalb der Garantiezeit werden fehlerhafte Teile kostenlos ersetzt. Die durch den Austausch entstehenden Kosten sind im Garantieanspruch nicht enthalten.

**Garantieansprüche können nur in Verbindung mit Original-Packlisten und Kaufbeleg in Anspruch genommen werden.**

Schadhafte oder defekte Einzelteile müssen vor dem Einbau beanstandet werden, da sonst der Garantieanspruch erlischt.

Von der Garantie sind Mängel ausgeschlossen, die bedingt sind durch:

- unsachgemäße Fundamente und Gründungen
- nicht gemäß dieser Anleitung durchgeführten Montage
- Schneelasten über 0,75 kN/m<sup>2</sup>
- eigene Veränderungen am Produkt
- fehlerhafte Pflege zur Erhaltung der vorhandenen Holzqualität
- das Vorherrschen von Windgeschwindigkeiten über Windstärke 7 (steifer Wind)  
Im Binnenland sind hierbei Auswirkungen wie z.B. die Bewegung ganzer Bäume und die fühlbare Hemmung beim Gehen im Freien zu beobachten. Bei Verursachung von Mängeln aufgrund dieser Bedingungen wird keine Gewährleistung übernommen.
- Naturkatastrophen oder anderweitige gewaltsame Einwirkungen.

**Bei Farbveränderungen, Rißbildung, Verzug oder ähnlichen Veränderungen, die bei Hölzern im Freien normal sind, besteht kein Reklamationsgrund. Auch die Dachplatten unterliegen Farbveränderungen.**

Weitergehende Ansprüche und Folgeschäden fallen nicht unter die Garantiebestimmungen. Es gelten unsere allgemeinen Geschäftsbedingungen.

## **WERKZEUG**

Folgendes Werkzeug sollten Sie vor Beginn der Montage zurecht gelegt haben.

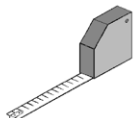

Bandmaß



Wasserwaage



Bleistift



Säge

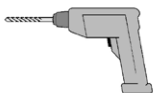

Bohrmaschine



Elektroschrauber

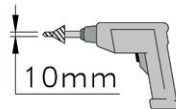

Kegelbohrer



Schraubzwingen



Schraubenschlüssel

## **HINWEIS**

In regelmäßigen Abständen sollten die Verschraubungen überprüft und nachgezogen werden. Dieses Produkt ist überwiegend aus Massivholz gefertigt und da es sich bei dem Werkstoff Holz um ein Naturprodukt handelt, kann es vorkommen das durch extreme Witterungseinflüsse, insbesondere nach langen Wärmeperioden, sich Trockenrisse bilden. Diese Trockenrisse sind keinesfalls ein Qualitätsmangel, sondern eine natürliche Erscheinung und je nach Wetterlage können sich diese Risse bis auf ein Minimum wieder verschließen. Darüber hinaus haben diese Trockenrisse, welche in Längsrichtung des Holzes auftreten, keinen Einfluss auf die Festigkeit und Belastbarkeit des Materials. Das heißt, die statischen Eigenschaften werden nicht beeinträchtigt.

Dear customer

Thank you very much for choosing a weka product.

- **Read these instructions through completely before assembling your product in order to avoid errors in assembly or damage.**

- **IMPORTANT**

**Please use the enclosed packing list to check immediately that your weka product has been delivered complete and intact.**

- Please do not dispose of the packing list before the guarantee period has expired. This list enables you to check that all the individual parts are present. It should be retained along with the proof of purchase. Any complaints which may arise can probably be easily rectified with this list. The item numbers on the packing list do not correspond to the item numbers in the following assembly instructions.
- We recommend that 3 people carry out the assembly.
- In order to prevent accidents, we recommend that children are kept out of the direct vicinity during assembly.
- We reserve the right to make further technological developments. This means that there may be minor deviations in the illustrations.
- Please do not simply throw away the packaging material. Paper, card and corrugated board as well as plastic packaging materials should be placed in the correct collection containers.

## **RECOMMENDATIONS**

- **Please drill pilot holes for all screw connections to avoid damaging the wood. The following symbol in the instructions will indicate when this is necessary:**



- Protect the wood from hours of direct sunlight and moisture.
- Wood is a natural product. Fluctuations in colour, knots and cracks are normal and have no influence on the statics.
- A prerequisite for successful assembly, is the anchoring of the studs in the concrete foundation using H stud supports. The stud supports are available as weka accessories for an additional cost.

**NOTE!**

- The dimensions are to be checked regularly during the course of the entire installation!

## **Wood protection**

The product is made from natural timber, for which regular and adequate wood preservation measures are obligatory. Please contact a wood preservation expert for information on professional preservation measures.

Wood preservation is to be carried out by the customer at his own risk. No guarantee can be given in the event of wood preservation not carried out in accordance with the instructions. Please also note the provisions relating to this in our guarantee. We wish you much pleasure with your wood product.

## **GUARANTEE CONDITIONS**

weka Holzbau GmbH provides you with a 5-year guarantee for design and processing quality. Within the guarantee time, faulty parts will be replaced free of charge. Costs arising as a result of the exchange are not included in the guarantee claim.

**Guarantee claims may only be made in conjunction with the original packing list and proof of purchase.**

Damaged or defective parts must be rejected prior to installation otherwise any warranty claim shall be terminated.

Excluded from the guarantee are defects caused by:

- improper subsoil and foundations
- assembly not carried out in accordance with these instructions
- snow load in excess of 0,75 kN/m<sup>2</sup>
- your own alterations to the product
- defective care in the maintenance of the current wood quality
- prevailing winds in excess of force 7 (stiff wind)  
Inland, consequences such as the movement of whole trees and any noticeable impedance when walking in the open air are to be observed. No defects due to these conditions will give rise to a guarantee.
- Natural catastrophes or other violent occurrences.

**Fluctuations in colour, crack formation, warping or similar changes which are completely normal outdoors are no grounds for making a claim.**

Further claims and consequential damage do not fall under the guarantee regulations. Our General Terms and Conditions apply.

## **TOOL**

You should have the following tools to hand before beginning assembly. (Not supplied.)

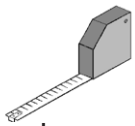

Spring tape measure



Spirit level



Pencil



Mitre saw/hand disk saw

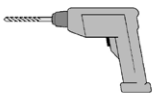

Drill



Electric screwdriver

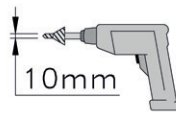

Taper drill



Screw clamp



Spanner

## **Information**

Il est conseillé de vérifier et de resserrer les assemblages vissés à intervalles réguliers. Ce produit est essentiellement fabriqué en bois massif. Le bois étant un matériau naturel, il se peut que des conditions climatiques extrêmes, notamment après de longues périodes de chaleur, entraînent la formation de fentes de sécheresse. Ces fentes de sécheresse ne constituent en aucun cas un défaut de qualité, mais un phénomène naturel. Selon la situation météorologique, ces fentes peuvent se refermer quasi-intégralement. De plus, ces fentes de sécheresse, qui apparaissent dans le bois dans le sens de la longueur, n'exercent aucune influence sur la solidité et la résistance du matériau. Autrement dit, les propriétés statiques ne sont pas affectées.

**Chère Cliente, cher Client**

**Nous vous remercions d'avoir choisi un produit weka.**

- Lisez entièrement la présente notice avant de procéder à l'assemblage afin d'éviter les erreurs et les dommages.
- **IMPORTANT !**  
**Veillez vérifier immédiatement, à l'aide de la liste des pièces, si le produit weka est arrivé complet et en bon état.**
- Ne détruisez la liste des pièces qu'une fois la garantie écoulee. Cette liste vous permet de vérifier si les pièces détachées sont complètes et doit être conservée avec le justificatif d'achat. Elle vous permettra de faire valoir aisément d'éventuelles réclamations. Les numéros de pos. de la liste des pièces ne sont pas identiques aux numéros de pos. de la présente notice de montage.
- Nous vous recommandons d'effectuer le montage à 3 personnes.
- Afin de prévenir tout accident, éviter la présence d'enfants à proximité durant le montage.
- Nous nous réservons le droit d'apporter aux produits des modifications dans le cadre de l'évolution technique. De légères différences sont par conséquent possibles par rapport aux illustrations.
- Ne pas jeter simplement le matériel d'emballage! Les emballages en papier, carton et carton ondulé doivent être déposés dans le container de tri correspondant.

## **RECOMMANDATIONS**

- **Pré-percez tous les assemblages vissés afin d'éviter d'endommager les éléments en bois!**  
**Ceci vous est rappelé par le symbole suivant dans la notice:**



- Evitez d'exposer le bois au soleil ou à l'humidité pendant des heures.
- Le bois est un produit naturel. Les différentes colorations, les nœuds et les fissures sont normaux et n'ont aucun effet sur la tenue statique.

### **ATTENTION !**

- Les cotes doivent être vérifiées régulièrement tout au long du montage!

## **CLAUSES DE GARANTIE**

Cet article est en bois brut naturel. Il est impératif d'entretenir et de protéger le bois régulièrement. Veuillez vous renseigner auprès d'un spécialiste du bois pour connaître les traitements appropriés.

Les mesures de protection du bois sont à effectuer par le client, sous sa propre responsabilité. Aucune garantie ne peut être accordée si le bois n'a pas été protégé selon les règles. Veuillez également vous reporter aux dispositions correspondantes de nos déclarations de garantie.

Nous vous souhaitons beaucoup de plaisir à l'usage de votre article en bois.

## **PROTECTION DU BOIS**

weka Holzbau GmbH accorde une garantie de 5 ans sur la construction et la qualité de fabrication. Au cours de la période de garantie, les pièces défectueuses sont remplacées gratuitement. Les coûts liés au remplacement ne sont pas couverts par la garantie.

**L'original de la liste des pièces et l'original du justificatif d'achat sont nécessaires pour faire valoir tous droits relatifs à la garantie.**

Des pièces défectueuses ou endommagées doivent faire l'objet d'une réclamation avant le montage, après celui-ci elles ne seront plus garanties.

La garantie ne couvre pas les vices dus à:

- des fondations et soubassements non conformes
- un montage non conforme aux présentes instructions
- des charges dues à la neige supérieures à 0,75 kN/m<sup>2</sup>
- des modifications du produit
- un manque d'entretien en vue du maintien de la qualité du bois
- la prédominance de vents d'une force supérieure à 7 (grand frais)

A l'intérieur des terres, tenir compte à ce sujet par ex. du fait que les arbres entiers bougent ou qu'il est difficile de se déplacer à l'extérieur. Aucun recours au titre de la garantie ne peut être accepté pour les vices consécutifs à ces situations.

- des catastrophes naturelles ou à l'emploi de la force.

**Les changements de couleur, la formation de fissures, la déformation ou les autres modifications de ce type sont normaux pour le bois à l'extérieur et ne constituent pas des motifs de réclamation.**

Les autres droits et dommages secondaires n'entrent pas dans le cadre des clauses de garantie. En application de nos conditions générales de vente.

## OUTIL

Pour le montage, nous vous recommandons de préparer les outils suivants.

(N'est pas compris dans la fourniture!)

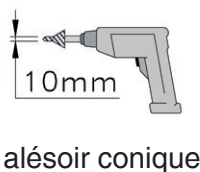
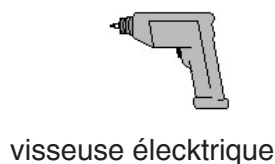
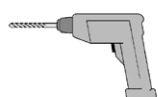
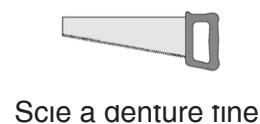
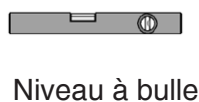
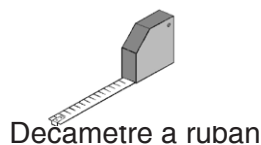

## remarque

Il est conseillé de vérifier et de resserrer les assemblages vissés à intervalles réguliers. Ce produit est essentiellement fabriqué en bois massif. Le bois étant un matériau naturel, il se peut que des conditions climatiques extrêmes, notamment après de longues périodes de chaleur, entraînent la formation de fentes de sécheresse. Ces fentes de sécheresse ne constituent en aucun cas un défaut de qualité, mais un phénomène naturel. Selon la situation météorologique, ces fentes peuvent se refermer quasi-intégralement. De plus, ces fentes de sécheresse, qui apparaissent dans le bois dans le sens de la longueur, n'exercent aucune influence sur la solidité et la résistance du matériau. Autrement dit, les propriétés statiques ne sont pas affectées.

**Egredi clienti,  
ci congratuliamo con voi per avere scelto un prodotto weka.**

- Prima del montaggio leggete con cura le presenti istruzioni al fine di evitare errori di montaggio o danni.
- **IMPORTANTE !**  
**Controllate subito con l'ausilio della lista di imballaggio che il prodotto weka sia stato fornito completo e senza danni.**
- Vi preghiamo di conservare la lista di imballaggio solo alla scadenza del periodo di garanzia. Questa lista serve per controllare la completezza della fornitura e deve essere conservata insieme allo scontrino. Con l'ausilio della lista è possibile risolvere eventuali reclami. I numeri di posizione della lista di imballaggio non corrispondono con i numeri di posizione delle seguenti istruzioni di montaggio.
- Raccomandiamo di eseguire il montaggio in 3 persone.
- Per scongiurare eventuali incidenti tenere lontano i bambini dal luogo di montaggio
- Ci riserviamo di apportare modifiche ai fini del progresso tecnologico. Per tale motivo è possibile che nelle rappresentazioni vengano a crearsi lievi differenze.
- Non gettare via il materiale di imballaggio! La carta, il cartone normale e ondulato cosiccome gli imballaggi in plastica devono essere smaltiti negli appositi contenitori di raccolta.

#### **RACCOMANDAZIONI**

- **Per evitare danni agli elementi in legno si raccomanda di preforare tutti i punti di avvitaggio a vite! Il presente simbolo richiama la vostra attenzione su tale particolare nel corso delle istruzioni:**



- Proteggete il legno dall'irradiazione solare diretta e dall'umidità prolungate.
  - Il legno è un prodotto naturale. Differenti irregolarità cromatiche, la ramificazione e la crepatura sono da considerarsi normali e non hanno alcuna influenza sulla statica.
- ATTENZIONE!**
- Durante il montaggio le misure devono essere controllate regolarmente!

#### **Protezione legno**

Il prodotto è composto dalla materia prima naturale del legno che rende le misure di protezione del legno assolutamente necessarie. Per il trattamento di protezione del legno a regola d'arte rivolgersi ad un esperto di protezione del legno.

Le misure di protezione del legno devono essere eseguite dal cliente sotto la sua responsabilità. Senza protezione del legno prescritta non può essere assunta nessuna garanzia. Osservare anche le disposizioni al riguardo nelle nostre dichiarazioni di garanzia.

Vi auguriamo un buon utilizzo del nostro prodotto legno.

#### **Condizioni di garanzia**

La weka Holzbau GmbH vi offre una garanzia di 5 anni sugli elementi costruttivi e sulla qualità di lavorazione. Durante il periodo di garanzia i componenti difettosi vengono sostituiti gratuitamente. La garanzia non comprende i costi causati dalla sostituzione di componenti difettosi.

**La garanzia può essere applicata solamente se accompagnata dalla lista di imballaggio e dallo scontrino di acquisto originali.**

Prima di procedere con il montaggio, le parti danneggiate o difettose devono essere eliminate, in caso contrario la garanzia decade.



La garanzia non copre difetti causati da:

- fondamenta e fondi non appropriati
- un montaggio non eseguito come specificato nelle presenti istruzioni
- carichi di neve maggiori di 0,75 kN/m<sup>2</sup>
- modifiche al prodotto apportate di propria iniziativa
- manutenzione errata del legno
- presenza costante di venti maggiori di forza 7  
nell'entroterra sono visibili effetti quali l'oscillazione di interi alberi e palesi difficoltà nel cammino all'aperto. il produttore non risponde nel caso di danni derivanti da tali cause.
- catastrofi naturali o altri fattori di intervento violento.

**Per modifiche cromatiche, formazione di crepe, distorsioni o simili cambiamenti, normali per legni all'aperto, non vi è motivo di reclamo.** La garanzia non copre ulteriori rivendicazioni e danni derivati. Valgono le nostre condizioni generali di vendita.

## UTENSILE

Prima di iniziare con il montaggio tenere a portata di mano i seguenti utensili.

(Non compreso nella fornitura!)

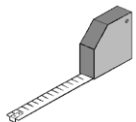

metro a nastro



livella ad acqua



Matita

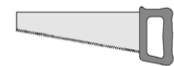

sega fine

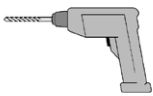

trapano



avvitatore elettrico

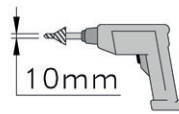

trapano conico

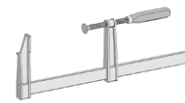

morsetto



chiave

## Avvertenza

Si raccomanda di controllare periodicamente tutti i collegamenti a vite e di riserrarli all'occorrenza. Questo prodotto è prevalentemente realizzato con legno massiccio e poiché nel materiale legno si tratta di un prodotto naturale, in seguito a condizioni atmosferiche estreme, in particolare durante i lunghi periodi estivi, non è da escludere una formazione di fessure di essiccamento. Queste fessure di essiccamento non sono in nessun caso un difetto di qualità, bensì un fenomeno naturale. A seconda delle condizioni atmosferiche queste fessure possono di nuovo chiudersi, lasciando soltanto uno spiraglio minimo. Inoltre, queste fessure di essiccamento, che si formano in senso longitudinale sul legno, non hanno alcun influsso sulla stabilità e sul carico del materiale. Ciò significa che non vengono in alcun modo pregiudicate le caratteristiche statiche.

**Apreciado cliente:**

**Gracias por haber elegido un producto weka.**

- Lea de principio a fin estas instrucciones de montaje con el objeto de evitar errores o desperfectos.
- **¡IMPORTANTE!**  
**Compruebe con la lista de embalaje si el producto weka ha llegado a sus manos completo e intacto.**
- No elimine la lista de embalaje antes de expirar el periodo de garantía. La lista sirve para controlar la integridad de las piezas y ha de guardarse junto con el comprobante de compra. Esta lista permite atender con éxito cualquier reclamación que pudiera surgir. Los números de artículo que figuran en la lista de embalaje no coincidan con los números especificados en las siguientes instrucciones de montaje.
- Le aconsejamos realizar el montaje con 3 personas.
- Para evitar accidentes, evite la presencia de niños en la cercanía inmediata durante el montaje.
- Nos reservamos el derecho a realizar modificaciones acordes con el progreso técnico. De ahí pueden surgir ligeras discrepancias en los dibujos y diagramas.
- ¡No tire el material de embalaje! Las envolturas de papel, cartón simple y cartón corrugado así como los elementos de embalaje de materia plástica han de llevarse a los contenedores respectivos.

**RECOMENDACIONES**

- **¡Por favor, haga previamente las perforaciones para todas las uniones atornilladas a fin de evitar daños en los elementos de madera! El siguiente pictograma le recordará esta indicación durante el montaje:**



- Evite exponer la madera durante horas enteras a los rayos solares directos o a la humedad.
- La madera es un producto natural. Los diferentes matices, nudos y fisuras son fenómenos normales que no afectan para nada la estática.

**¡ATENCIÓN!**

- ¡Se deben controlar regularmente las dimensiones durante todo el montaje!

**Protección de la madera**

El producto se compone de la materia prima natural madera. Esto hace que sea imprescindible tomar regularmente suficientes medidas de conservación de la madera. Para realizar un correcto tratamiento de conservación de la madera, póngase en contacto con un experto en conservación de maderas.

Las medidas de conservación de la madera las debe realizar el cliente bajo su responsabilidad. Sin una conservación de la madera según prescripción, no se puede asumir ninguna garantía. También tenga en cuenta las disposiciones que figuran en nuestra declaración de garantía a este respecto.

Le deseamos que disfrute de su producto de madera.

**GARANTIA**

La empresa weka Holzbau GmbH le concede una garantía de 5 años sobre la estructura y la calidad del procesamiento. Nos comprometemos a sustituir gratuitamente los elementos defectuosos durante el periodo de garantía. Los costes que ocasione el reemplazo de los elementos no están incluidos en la garantía. **Las pretensiones emanadas de la garantía serán aceptadas sólo en conexión con la lista de embalaje original y el comprobante original de compra.**

Las reclamaciones por piezas dañadas o defectuosas deben realizarse antes del montaje, dado que de lo contrario queda invalidado el derecho de garantía.

La garantía excluye desperfectos originados por:

- fundamentos y cimentaciones mal hechos
- un montaje no acorde con las presentes instrucciones
- cargas superiores a 0,75 kN/m<sup>2</sup> debidas a la nieve
- modificaciones del producto debidas al usuario
- cuidados inadecuados para preservar la calidad de la madera
- la presencia de vientos de fuerza 7 o más (vientos frescos)

Tierra adentro, los efectos se manifiestan en la agitación de árboles enteros y en una resistencia apreciable para andar a la intemperie. Los desperfectos que pudieran ocurrir debido a esas condiciones climáticas excluyen toda garantía por parte nuestra.

- Desastres naturales o efectos cuasi-catastróficos.

**No se aceptarán reclamaciones por cambios de matices, agrietamientos, desviaciones o alteraciones similares que son normales en la madera.**

Las cláusulas de garantía no incluyen otras pretensiones o daños inherentes. Rigen nuestras condiciones generales de negocio.

## **HERRAMIENTA**

Antes de emprender el montaje hay que tener a mano las siguientes herramientas.

(¡No figura en el suministro!)

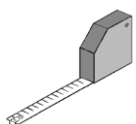

Cinta métrica



Nivel de burbuja



Lápiz



Sierra fina

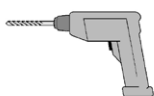

aladradora eléctrica



Destornillador eléctrico

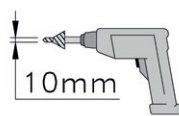

Taladro cónico



Prensa de tornillo



Llave plana

## **Nota**

As uniões roscadas devem ser vistoriadas e apertadas em intervalos regulares. Este produto é predominantemente manufacturado a partir de madeira maciça. Devido às influências climatéricas extremas e por se tratar de um produto natural, a madeira, poderão formar-se fissuras causadas pela secagem, especialmente após longos períodos de calor. Estas não são de modo algum resultantes da falta de qualidade, mas sim um fenómeno natural. Dependendo das condições climatéricas, as fissuras poderão voltar a fechar-se até ao mínimo.

Estas fissuras causadas pela secagem, que surgem na madeira no sentido longitudinal, não têm qualquer influência relativamente à resistência e à capacidade de carga do material. Isto quer dizer que as características estáticas não são afectadas.

Estimada(o) Cliente,  
Parabéns por ter escolhido um produto weka!

- **Antes de proceder à montagem, leia o presente manual de instruções na íntegra, por forma a evitar erros de montagem ou danos.**
- **IMPORTANTE !**  
**Com base na lista da embalagem, verifique de imediato se o produto weka está completo e se não apresenta danos.**
- Conserve a lista da embalagem até o período de garantia expirar. Esta lista serve para verificar se as peças se encontram completas e deverá ser guardada juntamente com o comprovativo da compra. Esta lista permite ainda a resolução imediata de eventuais reclamações. As posições da lista da embalagem não coincidem com as posições das seguintes instruções de montagem.
- Recomendamos que a montagem seja efectuada por 3 pessoas.
- Com vista à prevenção de acidentes, há que evitar a presença de crianças nas proximidades do local de montagem.
- Reservamo-nos o direito a alterações decorrentes de avanços tecnológicos, na sequência dos quais os desenhos poderão apresentar diferenças não muito significativas.
- Não descarte o material de embalagem de qualquer maneira! As embalagens de papel, cartão e cartão ondulado, bem como partes da embalagem em plástico deverão ser colocadas nos respectivos recipientes colectores.

### **RECOMENDAÇÕES**

- **Fure previamente todas as uniões roscadas por forma a evitar danos nas peças de madeira! Ao longo do presente manual de instruções, o seguinte símbolo chamará a sua atenção para esta necessidade:**



- Proteja a madeira da exposição directa e prolongada aos raios solares ou à humidade.
- A madeira é um produto natural. As diferentes colorações, os nós e a formação de fendas são normais e não exercem qualquer influência sobre a estabilidade.

#### **ATENÇÃO!**

- Deve controlar regularmente as medidas ao longo de todo o trabalho de montagem!

### **PRESERVAÇÃO DE MADEIRAS**

O produto é composto por matéria-prima natural, neste caso, a madeira. Isto torna obrigatoriamente necessário que sejam tomadas com regularidade medidas de preservação da madeira. Para um tratamento adequado de preservação da madeira, dirija-se a um especialista da área.

A tomada de medidas de preservação da madeira é da responsabilidade do cliente. Não é concedida garantia no caso de não ser efectuada uma preservação da madeira de acordo com as medidas regulamentadas. Tenha também em atenção as nossas condições de garantia a este respeito.

Esperamos que se divirta com o seu produto de madeira.

### **CONDIÇÕES DE GARANTIA**

A Empresa weka Holzbau GmbH garante-lhe 5 anos de garantia sobre a qualidade da construção e do processamento. Durante o período de garantia, as peças com defeito serão substituídas gratuitamente. Os custos inerentes às substituições não são cobertos pela garantia.

A garantia poderá apenas ser concedida mediante a apresentação da lista da embalagem original e do comprovativo original de compra. As peças individuais danificadas ou com defeitos devem ser alvo de reclamação antes da montagem, caso contrário a garantia perde a validade.

A garantia exclui falhas condicionadas por:

- fundações e bases inadequadas
- montagem não efectuada de acordo com as nossas instruções de montagem
- sobrecargas de neve acima de 0,75 kN/m<sup>2</sup>
- alterações voluntariamente implementadas no produto
- tratamento deficiente com vista à manutenção da qualidade da madeira
- a predominância de ventos com velocidades acima da intensidade 7 (vento forte)

No interior do país é possível verificar consequências como a movimentação de árvores e entraves perceptíveis à locomoção ao ar livre. Não é concedida garantia em caso de falhas derivadas destas condições.

- Catástrofes naturais ou qualquer outro tipo de motivos de força maior.

**Em caso de alterações da cor, formação de fendas, deformações ou alterações similares, normais em madeiras expostas ao ar livre, não existe qualquer fundamento para reclamar a garantia.** A garantia não cobre quaisquer outras reivindicações e danos subsequentes. Vigoram as nossas condições gerais de venda.

## **FERRAMENTA**

Antes de dar início à montagem, deverá ter à mão as seguintes ferramentas.

(Não faz parte do material a fornecer!)

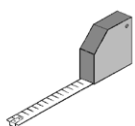

Fita métrica com



Nivel de bolha de ar



Lápis



Serra fina

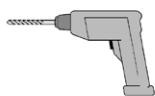

Berbequim



Aparafusadora

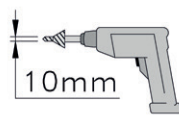

Broca cónica



Grampo de fixação



Chave de parafusos

## **Nota**

As uniões roscadas devem ser vistoriadas e apertadas em intervalos regulares. Este produto é predominantemente manufacturado a partir de madeira maciça. Devido às influências climatéricas extremas e por se tratar de um produto natural, a madeira, poderão formar-se fissuras causadas pela secagem, especialmente após longos períodos de calor. Estas não são de modo algum resultantes da falta de qualidade, mas sim um fenómeno natural. Dependendo das condições climatéricas, as fissuras poderão voltar a fechar-se até ao mínimo. Estas fissuras causadas pela secagem, que surgem na madeira no sentido longitudinal, não têm qualquer influência relativamente à resistência e à capacidade de carga do material. Isto quer dizer que as características estáticas não são afectadas.

**Geachte klant,**

**Wij zijn u erkentelijk dat u voor een product van weka hebt gekozen.**

- Lees deze handleiding vóór de montage helemaal om montagefouten of beschadigingen te vermijden.  
**BELANGRIJK!**
- **Controleer direct aan de hand van de paklijst of het product van weka volledig en onbeschadigd bij u is aangekomen.**
- Vernietig de paklijst pas na afloop van de garantieperiode. Deze lijst is voor de controle op volledigheid van alle onderdelen en moet met de kassabon worden bewaard. Eventuele reclames kunnen met behulp van deze lijst probleemloos worden opgelost. De pos.-nummers van de paklijst komen niet overeen met de pos.-nummers van de volgende montagehandleiding.
- Wij adviseren de montage met 3 personen uit te voeren.
- Om ongevallen te voorkomen, moet worden vermeden dat kinderen zich tijdens de montage in de directe nabijheid bevinden.
- Ontwikkelingen in de zin van technische vooruitgang behouden wij ons voor. Op deze wijze kunnen kleine afwijkingen in de afbeeldingen ontstaan.
- Verpakkingsmateriaal niet zomaar weggooien! Verpakking van papier, karton, golfkarton en kunststof moet in de betreffende verzamelcontainer worden gedeponeerd.

### **Advies**

- **Alle schroefverbindingen voorbereiden om beschadiging van de houten delen te voorkomen. Het volgende symbool maakt u in de handleiding nogmaals hierop opmerkzaam:**

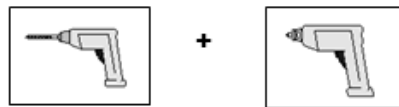

- Bescherm het hout tegen urenlang, direct zonlicht of vocht.
- Hout is een natuurproduct. Verschillende kleurschakeringen, knoesten en scheurvorming zijn normaal en hebben geen invloed op de stevigheid.  
**OPGELET!**
- U dient de afmetingen tijdens het monteren regelmatig te controleren!

### **HOUTBESCHERMING**

Het product bestaat uit de natuurlijke grondstof hout. Dit maakt het noodzakelijk regelmatig voldoende maatregelen uit te voeren om het hout te beschermen. Voor een vakkundige beschermende behandeling van het hout dient u zich tot een deskundige op het gebied van houtbescherming te wenden.

Maatregelen voor de bescherming van het hout moeten door de klant voor eigen verantwoordelijkheid worden uitgevoerd. Zonder bescherming van het hout volgens voorschrift kan geen garantie worden geboden. Neem ook onze garantiebepalingen dienaangaande in acht.

Wij wensen u veel plezier met uw houten product.

### **Garantiebepalingen**

De firma weka Holzbau GmbH geeft u 5 jaar garantie op constructie en verwerkingskwaliteit. Binnen de garantieperiode worden onderdelen met gebreken gratis vervangen. De kosten van vervanging behoren niet tot de garantie.

**Aanspraak op garantie kan uitsluitend in combinatie met de originele paklijst en de originele kassabon worden behandeld.**

Evt. reclames over beschadigde of defecte onderdelen dient u voor het monteren te melden, omdat u anders geen recht hebt op garantie.

Uitgesloten van garantie zijn gebreken die veroorzaakt zijn door:

- verkeerde funderingen
- montage die niet volgens deze handleiding is uitgevoerd
- sneeuwbelasting van meer dan  $0,75 \text{ kN/m}^2$
- eigen veranderingen aan het product
- verkeerde behandeling voor conservering van het hout
- windsnelheden hoger dan windkracht 7 (harde wind)
  - In het binnenland is dit o.a. te merken aan bomen die in hun geheel bewegen en aan een voelbare weerstand bij het buiten lopen. Gebreken die door deze omstandigheden ontstaan, vallen niet onder de garantie.
- natuurrampen of gebruik van geweld

**Kleurveranderingen, scheurvorming, vervorming of soortgelijke veranderingen die normaal zijn bij hout in de buitenlucht, zijn geen reden voor reclames.**

Verderstrekkende aanspraak en gevolgschade vallen niet onder de garantie. Van toepassing zijn onze algemene voorwaarden.

### **Gereedschap**

Het volgende gereedschap moet u vóór het begin van de montage gereed hebben liggen.

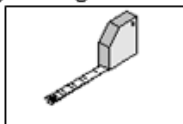

rolmaat/meetlint

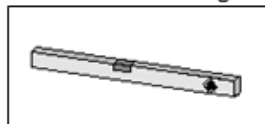

waterpas

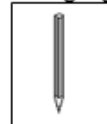

potlood

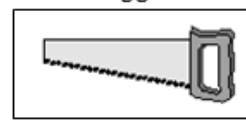

zaag



boormachine



fittingschroevendraaier

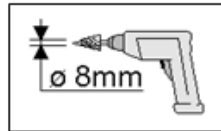

conische boor  
 $\varnothing 8\text{mm}$

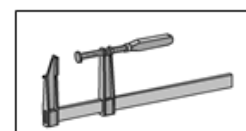

lijmklem

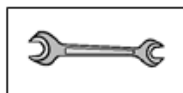

schroefsleutel

### **Aanwijzing**

De schroefverbindingen dienen regelmatig gecontroleerd en aangedraaid te worden. Dit product bestaat grotendeels uit massief hout. Aangezien hout een natuurproduct is, kunnen er door extreme weersomstandigheden, met name na lange warmteperiodes, drogingsscheuren ontstaan. Deze scheuren vormen in geen geval een kwaliteitsvermindering, maar zijn een natuurlijk verschijnsel. Afhankelijk van de weersituatie kunnen deze scheuren zich weer grotendeels sluiten.

Daarnaast hebben deze droogtescheuren, die in de lengterichting van het hout optreden, geen invloed op de sterkte en belastbaarheid van het materiaal. Met andere woorden, de statische eigenschappen blijven behouden.

Štovani kupci,  
zahvaljujemo se što ste se odlučili za weka – proizvod.

- Prije postavljanja pročitajte kompletno ovo uputstvo, kako bi spriječili greške ili oštećenja prilikom montaže.

**VAŽNO !**

**Molimo provjerite smjesta na osnovu popisa dijelova da li je proizvod stigao do Vas kompletan i neoštećen.**

- Molimo da bacite popis pakovanja tek nakon što istekne garancija. Taj popis služi kao kontrola kompletnosti pojedinih dijelova i treba ga sačuvati zajeno s potvrdom o kupnji. Eventualne reklamacije se pomoću tog popisa mogu bez problema riješiti. Brojevi pozicija popisa pakovanja ne odgovaraju brojevima pozicija narednih uputstava za montažu.
- Preporučujemo da montažu provedete s 3 osobe.
- Da bi spriječili nesreće nemojte dozvoliti da se za vrijeme montaže u neposrednoj blizini nalaze djeca.
- Dozvoljavamo si pravo na daljnji razvoj u smislu tehničkog napretka. Tako može doći do neznatnih odstupanja od slikovitih prikaza.
- Nemojte jednostavno baciti ambalažu! Ambalažu od papira, kartona i valovitog kartona, kao i dijelove od plastične mase treba staviti u odgovarajuće kontejnere za sakupljanje.

### Preporuke

- **Molimo da sve vijčane spojeve prethodno izbušite kako biste spriječili oštećenja na drvenim dijelovima! Slijedeći znak Vas još jednom tokom uputstava na to upozorava:**

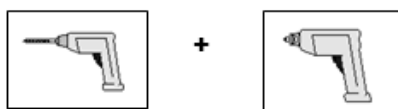

- Zaštitite drvo od direktnog višesatnog djelovanja sunca i od vlage.
  - Drvo je proizvod prirode. Razna obojenja, čvorovi i stvaranje pukotina su normalni i ne utiču na statiku.
- PAŽNJA!**
- Tijekom kompletne montaže neophodno je redovito provjeravati dimenzije!

### zaštita za drvo

Proizvod je izrađen od prirodnog drveta. Zbog toga su nužne redovite i odgovarajuće mjere zaštite drveta. Informacije o profesionalnoj zaštiti drveta zatražite od stručnjaka u zaštiti drveta.

Mjere zaštite drveta kupac provodi na vlastitu odgovornost. U slučaju neprovođenja pravilne zaštite drveta ne preuzimamo nikakvu odgovornost. Pregledajte odredbe našeg jamstva koje se odnose na ovo pitanje. Želimo Vam mnogo zadovoljstva pri korištenju Vašeg proizvoda od drveta.

### Odredbe garancije

Firma weka Holzbau GmbH Vam daje 5 godina garancije na konstrukciju i kvalitetu obrade. Unutar perioda garancije se neispravni dijelovi besplatno zamjenjuju. Troškovi koji nastanu usljed zamjene nisu obuhvaćeni u zahtjevima garancije.

**Pravo na garanciju se može ostvariti samo u vezi s originalnim popisom pakovanja i originalnim kupovnim računom.**

Oštećeni ili neispravni dijelovi moraju se reklamirati prije ugradnje jer se inače ne uvažava jamstveni zahtjev.



Prije garancije su isključeni nedostaci koji su uvjetovani usljed:

- nestručnih temelja i potporišta
- montaže koja nije provedena prema ovom uputstvu
- opterećenja usljed snijega iznad 0,75 kN/m<sup>2</sup>
- vlastitih izmjena na proizvodu
- neispravne njege za sačuvanje postojeće kvalitete drveta
- brzine vjetrova pretežno iznad 7 bofora (snažni vjetar)
  - U unutrašnjosti zemlje se to očituje kao npr. gibanje čitavih stabala i osjetna smetnja prilikom hodanja na otvorenom. Ako dođe do neodstataka uzrokovanih takvim uslovima ne preuzima se nikakva garancija.
- Prirodne katastrofe i drugo nasilno djelovanje

**U slučaju izmjene boje, stvaranja pukotina, deformacija i sličnih promjena, koje su normalne kod drva na otvorenom, ne postoji razlog za reklamaciju.**

Daljnji zahtijevi i štete kao posljedica ne spadaju pod odredbe o garanciji. Vrijede naši općii uslovi o poslovanju.

## **alat**

Slijedeći alat bi trebali pripremiti prije početka montaže.

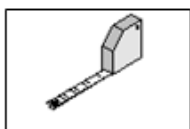

metarska mjerna traka

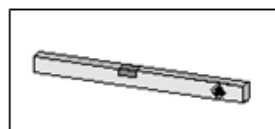

Libela

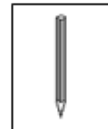

olovka

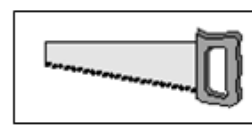

pila

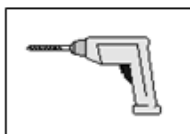

bušilica



elektro-odvijač

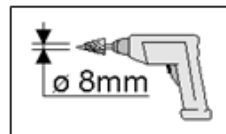

stožasto svrdlo

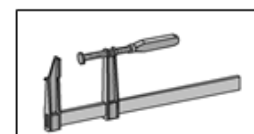

zatezač za drvo

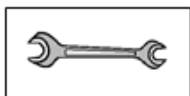

ključ za vijke

## **Uputa**

Potrebno je provjeriti i naknadno pritegnuti vijčane spojeve u redovitim razmacima. Ovaj proizvod se uglavnom proizvodi od punog drveta, a kako se kod drveta radi o prirodnom proizvodu, pod vremenskim utjecajem, posebice nakon dugih razdoblja topline, mogu se usljed suše stvoriti napuknuća. Ova napuknuća usljed suše nisu nikakav nedostatak glede kvalitete, već prirodna pojava i, ovisno o vremenskom položaju, mogu se ponovno svesti na minimum.

Sukladno tomu ova napuknuća koja se pojavljuju uzdužno usljed suše nemaju utjecaja na čvrstoću i nosivost materijala. To znači da nisu ugrožena statička svojstva objekta.

**Spoštovani kupec!**

**Najlepša hvala, da ste se odločili za weka izdelek.**

- Preden začnete z gradnjo, natančno preberite to navodilo, da se boste tako lahko izognili napakam pri montaži ali poškodbam.

**POZOR!**

- **S pomočjo ovojnega lista takoj preverite, če se prejeli weka izdelek nepoškodovan in v celoti.**
- Ovojni list uničite šele po poteku garancijske dobe. Ta list vam bo služil za kontrolo popolnosti posameznih delov in hraniti ga morate skupaj z računom. Morebitne napake se lahko s pomočjo tega lista brez problemov odpravijo. Pozicijske številke ovojnega lista se ne ujemajo s pozicijskimi številkami naslednjega navodila za montažo.
- Priporočamo vam, da montažo izvedete z dvema osebama.
- Da bi preprečili morebitne nesreče, se otroci v času montaže naj ne nahajajo v neposredni bližini.
- V smislu tehničnega napredka si pridružujemo pravico do nadaljnjega razvoja. Tako lahko v prikazih pride do majhnih odstopanj.
- Ovojnega materiala ne odvrzite kar tako! Papirnato embalažo, embalažo iz lepenke in valovite lepenke, kakor tudi embalažne dele iz plastike odvrzite v ustrezne zbiralne posode.

### Priporočilo

- **Da bi se izognili poškodbam na lesenih delih, navrtajte navojne spoje! Sledeči znak vas med navodilom na to opozori še enkrat:**

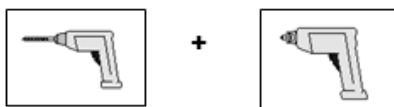

- Les zaščitite pred daljšimi, direktnim vplivi sonca ali vlage.
- Les je naravni izdelek. Različna obarvanja, veje in nastajanje razpok so normalni pojavi in nimajo vpliva na statiko.

**POZOR!**

- Mere preverjajte med celotnim postopkom montaže!

### ZAŠČITA LESA

Izdelek je iz naravne surovine, lesa. Zato so redni, zadostni ukrepi za zaščito lesa nujno potrebni. Za strokovno zaščitno obdelavo lesa se obrnite na strokovnjaka za les.

Ukrepe za zaščito lesa morajo stranke izvesti na lastno odgovornost. Brez predpisane zaščite lesa ne moremo priznati garancije. Prosimo, upoštevajte tudi s tem povezana določila v naši garancijski izjavi. Z lesnim izdelkom vam želimo mnogo veselja.

### Garancijska določila

Podjetje weka Holzbau d.o.o. vam zagotavlja petletno garancijo na konstrukcijo in kvaliteto obdelave. V času garancije se poškodovani deli nadomestijo brezplačno. Stroški, ki nastanejo z zamenjavo, ne spadajo pod garancijo.

**Pravice iz garancije se lahko terjajo le v povezavi z originalnim ovojnim listom in računom.**

Poškodovane ali nedelujoče dele pred vgradnjo reklamirajte, sicer garancijske pravice ne bodo veljavne.

Pod garancijo ne spadajo napake, ki so pogojene z:

- nepravilnimi temelji in temeljenjem
- montažo, ki ni izpeljana v skladu s tem navodilom
- snežnimi obremenitvami preko 0,75 kN/m<sup>2</sup>
- lastnimi spremembami na izdelku
- pomanjkljivim vzdrževanjem za ohranitev obstoječe kvalitete lesa
- prevladovanjem hitrosti vetra preko moč vetra 7 (močan veter)
  - V notranjosti je pri tem potrebno upoštevati učinkovanje kot npr. gibanje celih dreves in občutno oviranje pri hoji na prostem. Pri povzročitvi poškodb na osnovi teh pogojev garancija ne velja.
- naravnimi nesrečami ali drugimi nasilnimi delovanji.

**Pri barvnih spremembah, nastajanju razpok, izkrivljanju ali podobnih spremembah, ki so pri lesu na prostem normalni pojav, ni vzroka za reklamacijo.**

Nadaljnje pravice in posledične škode ne spadajo v garancijska določila. Veljajo naši splošni poslovni pogoji.

## **Orodje**

Pred začetkom montaže si pripravite sledeče orodje.

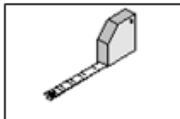

tekoča mera / šiviljska mera

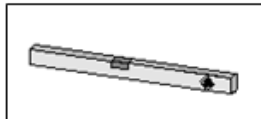

Vodna tehtnica

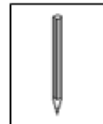

Svinčnik

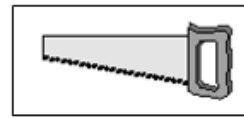

žaga

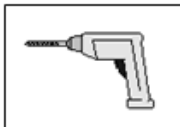

vrtalni stroj



električni vijačnik

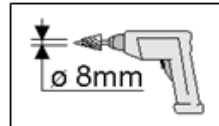

konusni sveder

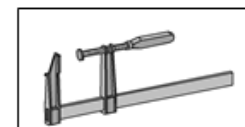

primež

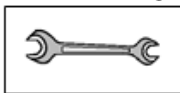

vijačni ključ

## **napotek**



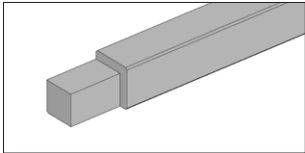
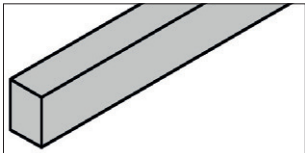
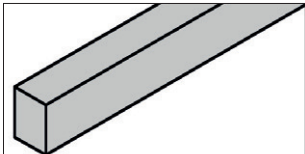
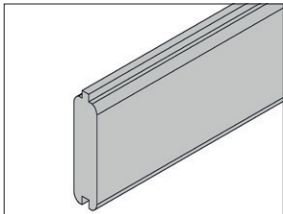
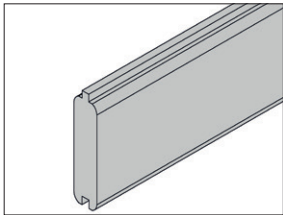
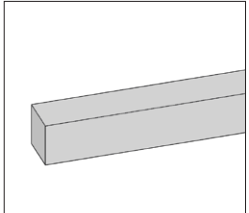
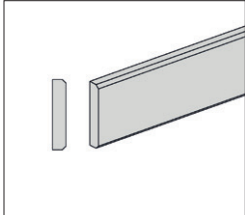

Redno preverjajte vijake in jih po potrebi privijte. Izdelek je večinoma izdelan iz masivnega lesa in ker je les naravni material, lahko zaradi vremenskih vplivov, predvsem dolgega vročinskega obdobja, nastanejo razpoke. Razpoke nikakor ne pomenijo slabe kakovosti, ampak so običajen pojav in jih lahko glede na vremenske razmere dobro ponovno zamašite.

Pri tem te razpoke, ki nastanejo vodoravno na les, ne vplivajo na trdnost in nosilnost materiala. To pomeni, da se statistične lastnosti ne spremenijo.

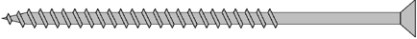
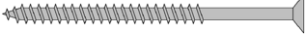

# Stückliste - Parts list

Pos	Bild	Abmessung ( mm )	Anzahl ( Stück )	
			657.2626.09.00	657.3535.09.00
①	G651.02.0006 	90/90/2150	2	2
②	G650.01.0011 G650.01.0001 	50/70/1990 50/70/2850	1 -	- 1
③	R002.0640.0900 G100.14.0001 	50/70/900 50/70/1220	2 -	- 2
④	G650.01.0031 R002.0035.2850 	28/121/1990 28/121/2850	18 -	- 18
⑤	R002.0035.0900 R002.0035.1215 	28/121/900 28/121/1215	36 -	- 36
⑥	G100.01.0054 	28/28/2160	6	6
⑦	R002.0400.2300 	11/58/2300	6	6

M657.002

Pos	Bild	Abmessung ( mm )	Anzahl ( Stück )
M1	K001.8050.0004 	5,0 x 80	6
M2	K001.6040.0004 	4,0 x 60	30
M3	K001.4040.0004 	4,0 x 40	220
M4	K001.3535.0004 	3,5 x 35	40
M5	K002.4050.0004 	5,0 x 40	35
M6	K031.1010.0001 	100/60/100	4

1

	M5 5,0 x 40
	M6 100/60/100

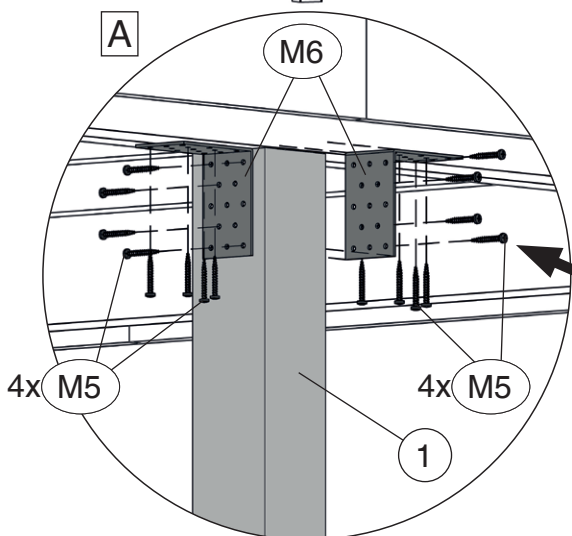
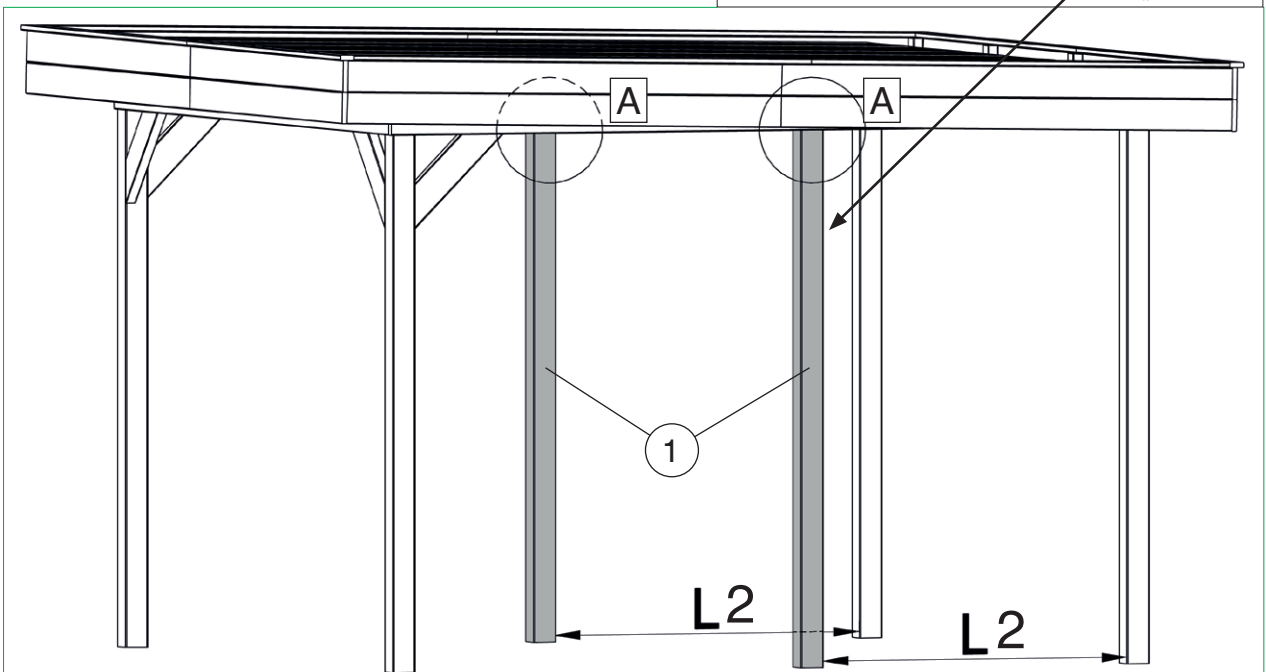
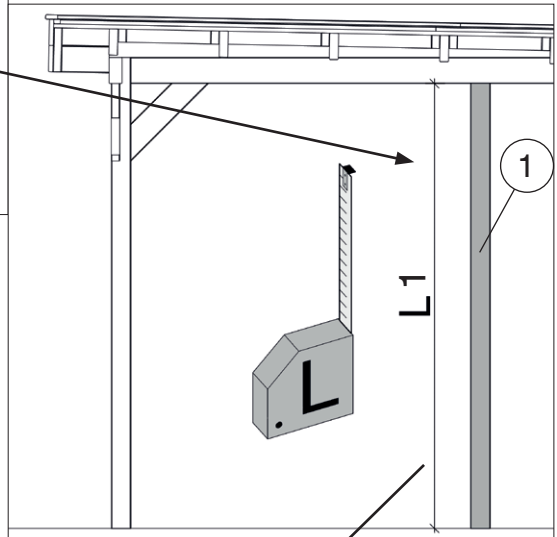
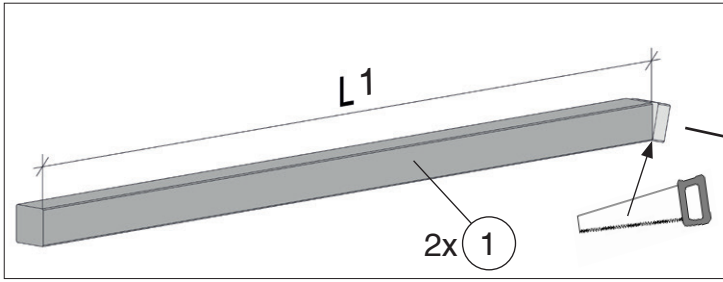

Art.-Nr.	L 2 mm
657.2626.	900
657.3535.	1215

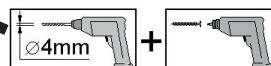

2

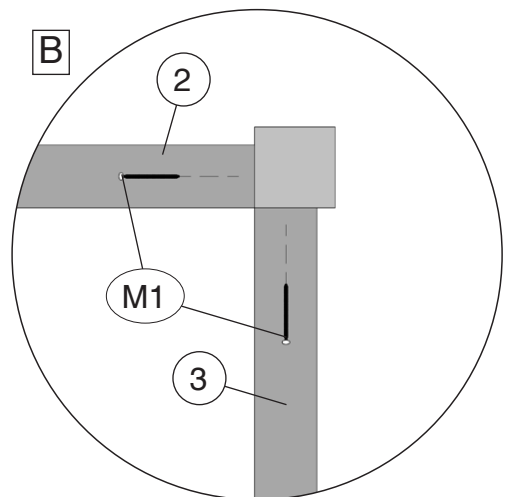
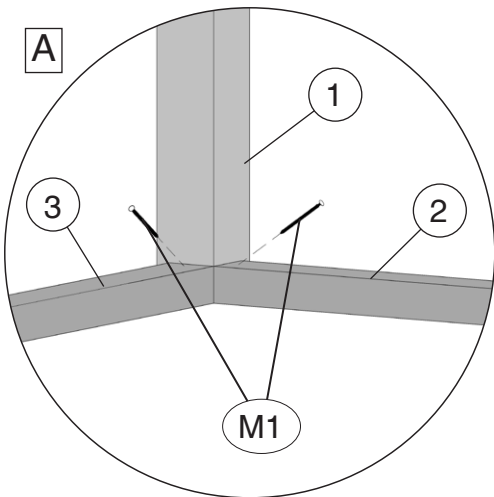
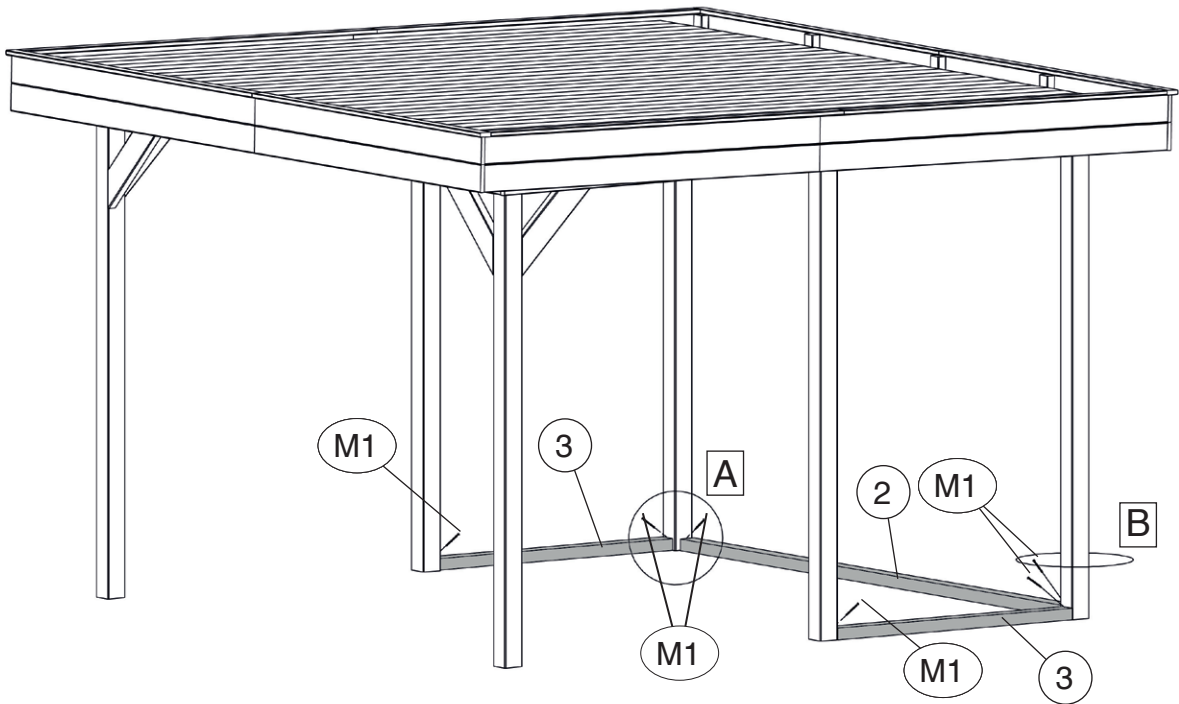
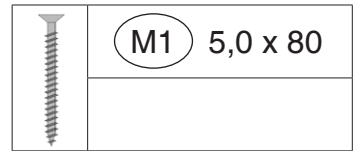
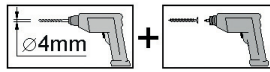

3

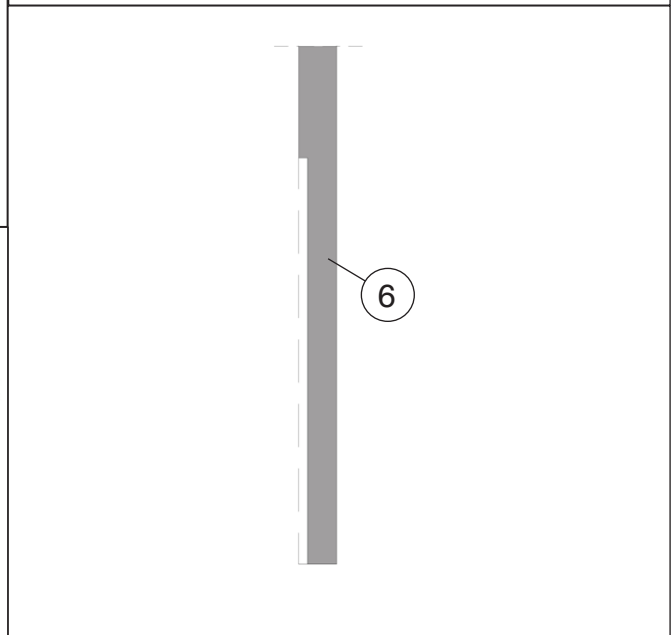
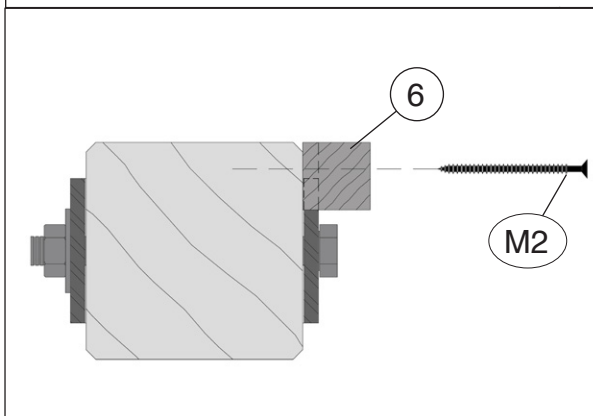
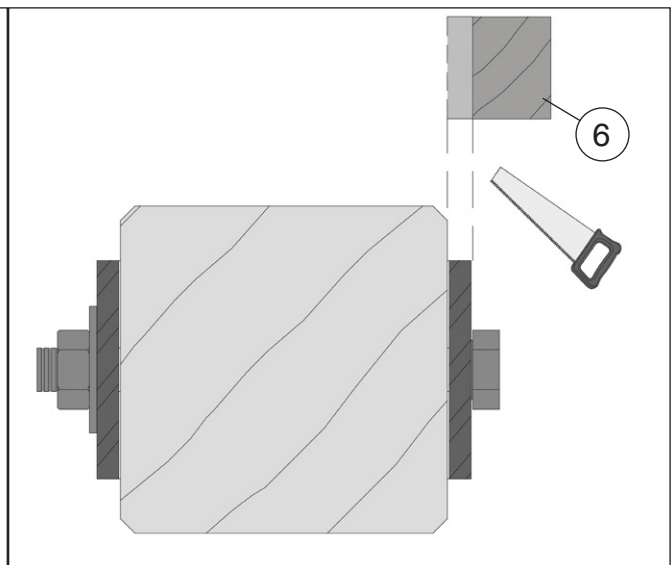
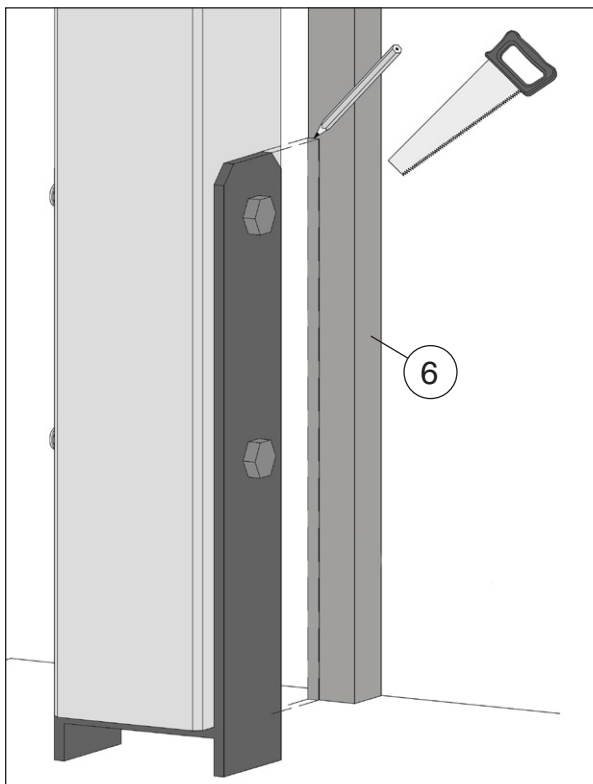
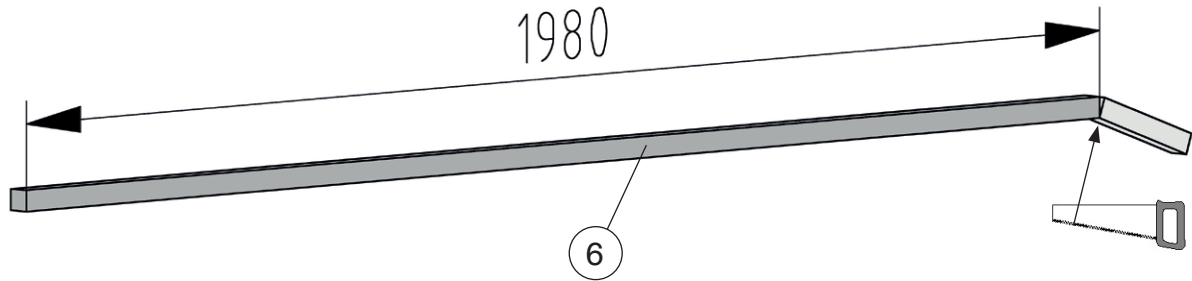
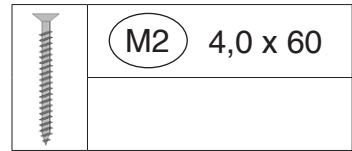
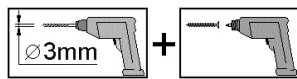



3

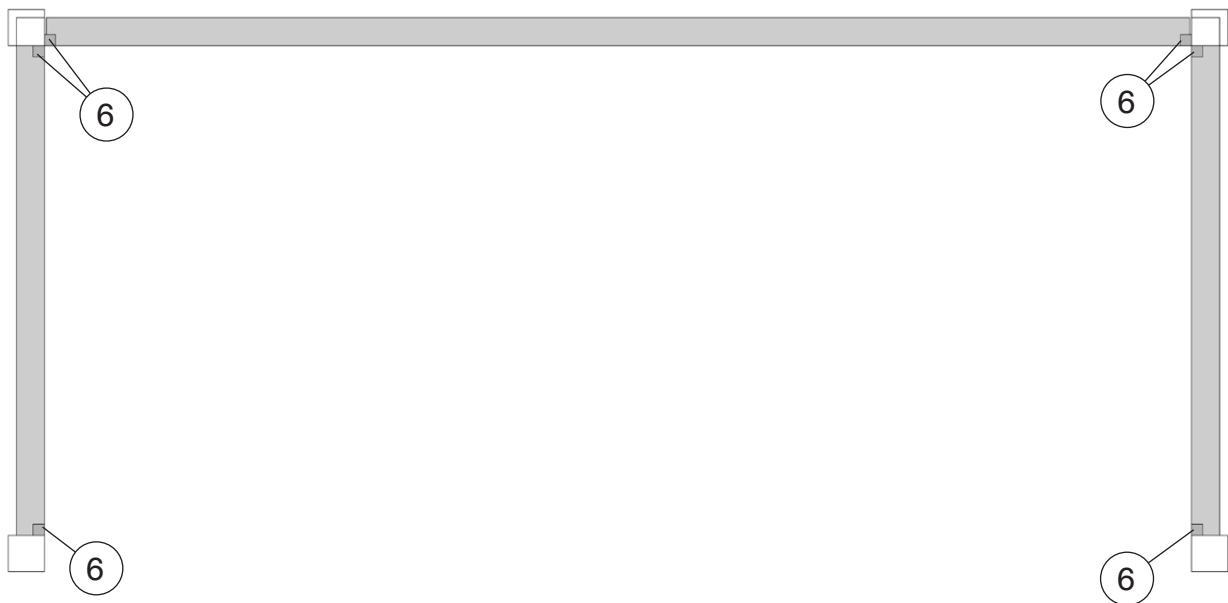
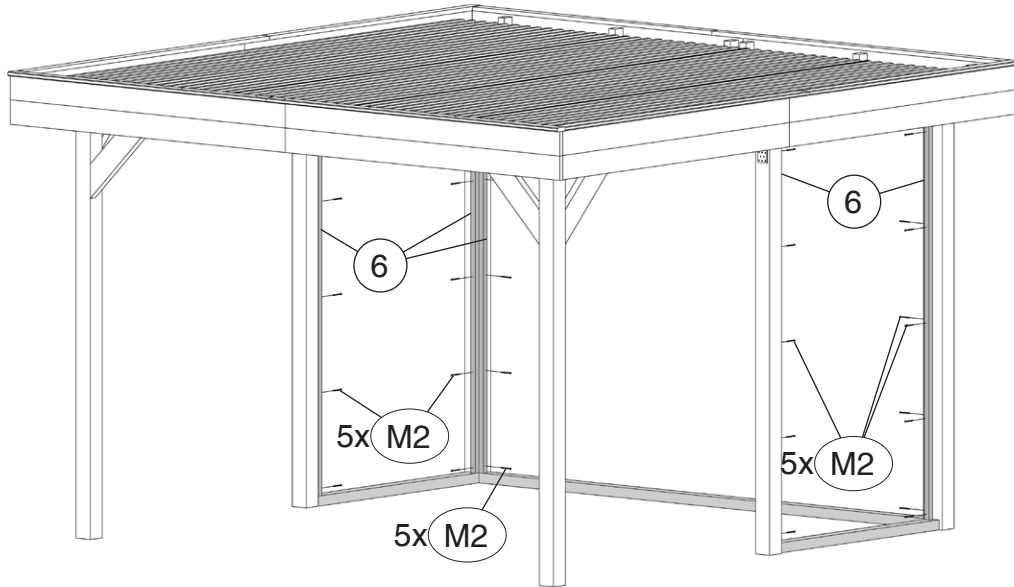
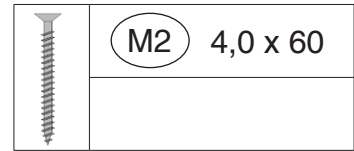
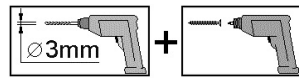

4

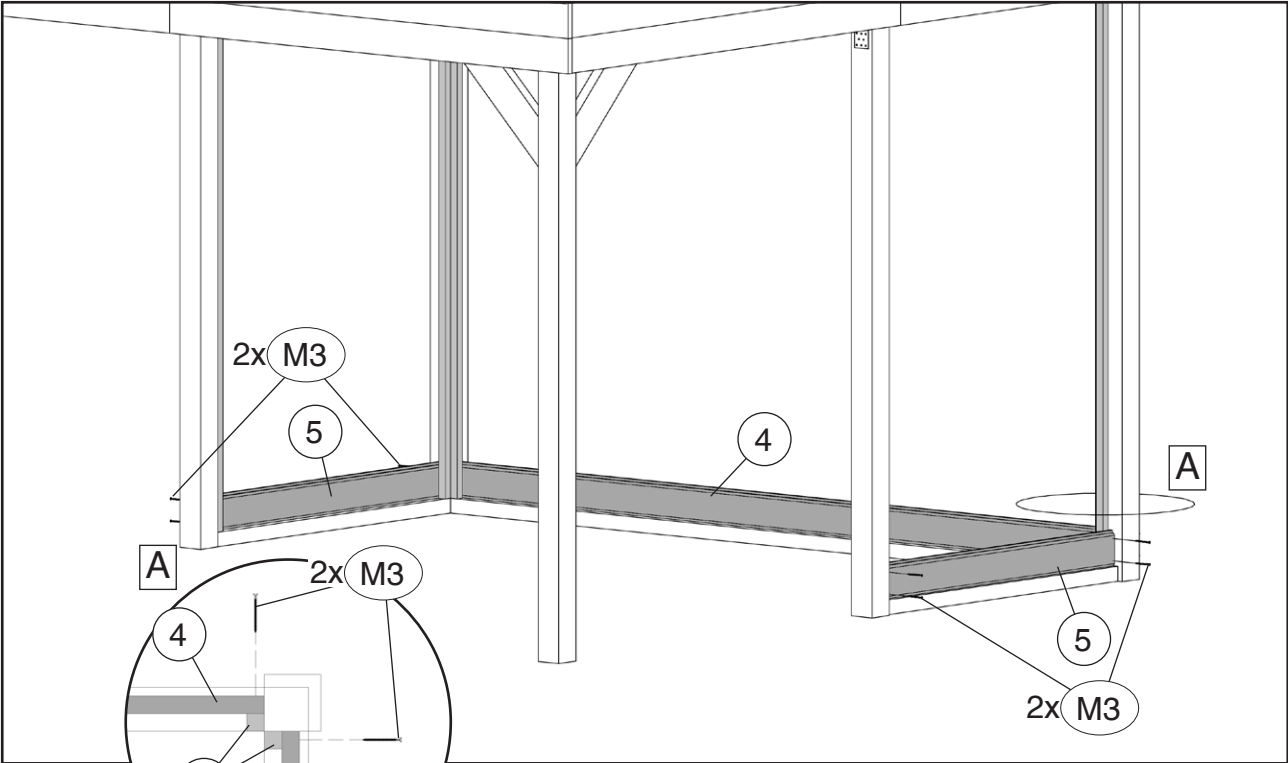
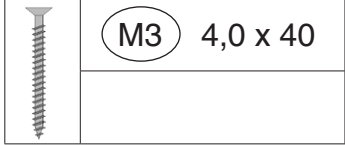
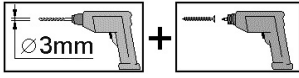

5

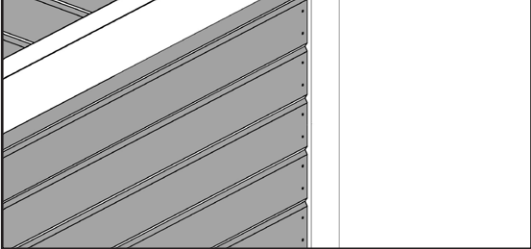
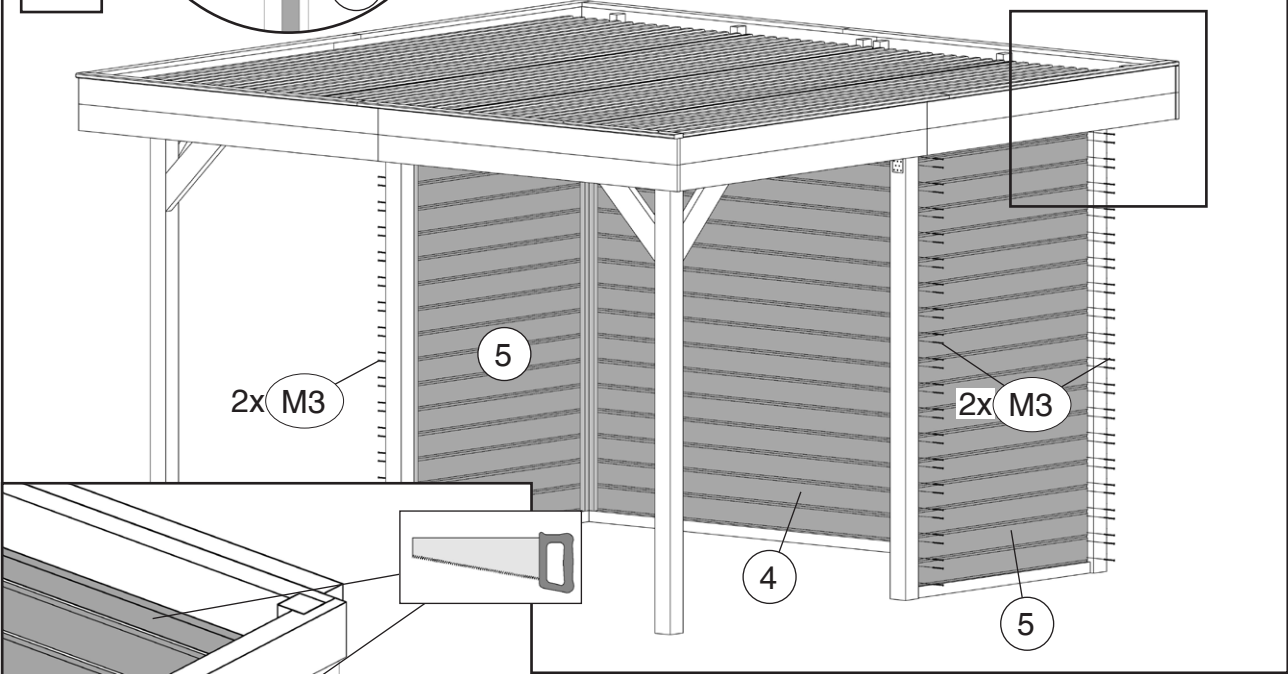

6

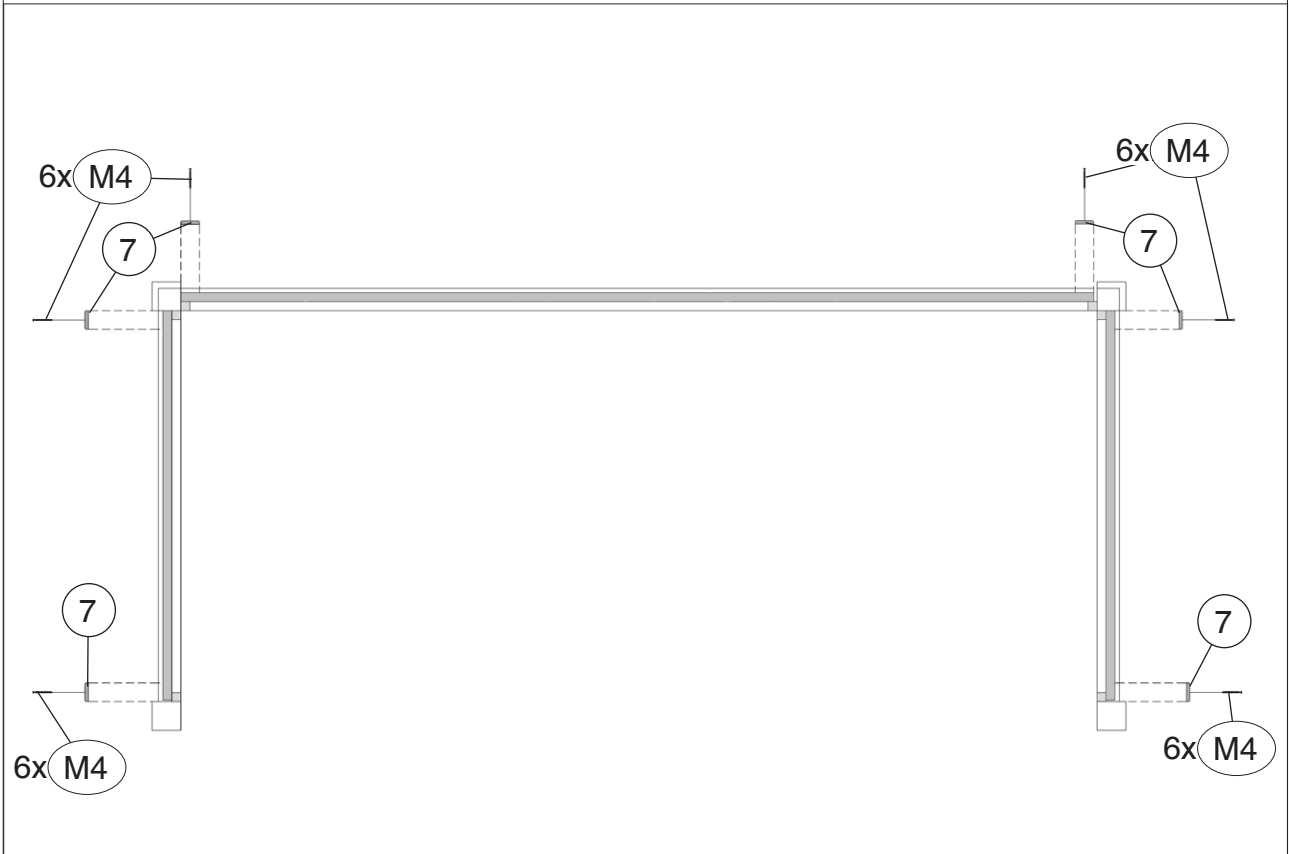
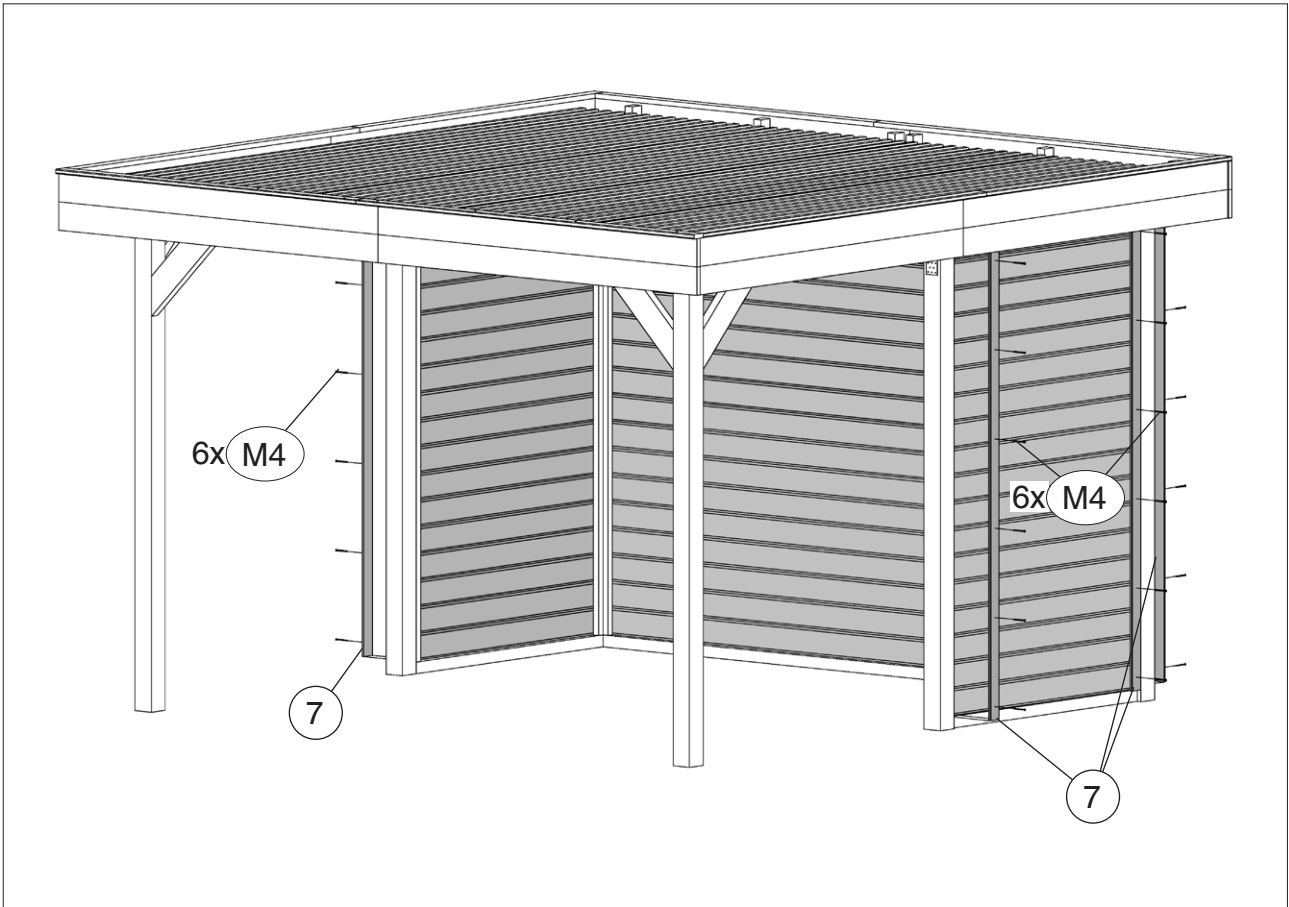

[www.weka-holzbau.com](http://www.weka-holzbau.com)



## **WEKA Holzbau GmbH**

Johannesstr. 16, 17034 Neubrandenburg

Tel.: +49 (0)395 42908-0

Fax: +49 (0)395 42908-83

Mail: [info@weka-holzbau.com](mailto:info@weka-holzbau.com)

Web: [www.weka-holzbau.com](http://www.weka-holzbau.com)

MA Art.-Nr.: 800.0286.05.46