

Technische Daten

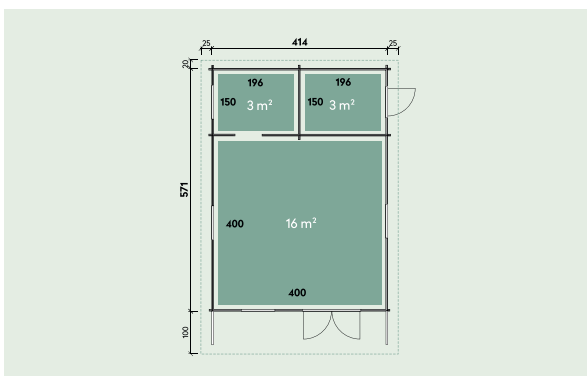

Artikelnummer:

570 200



Kontrolliert durch:

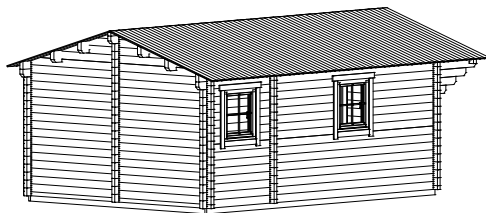
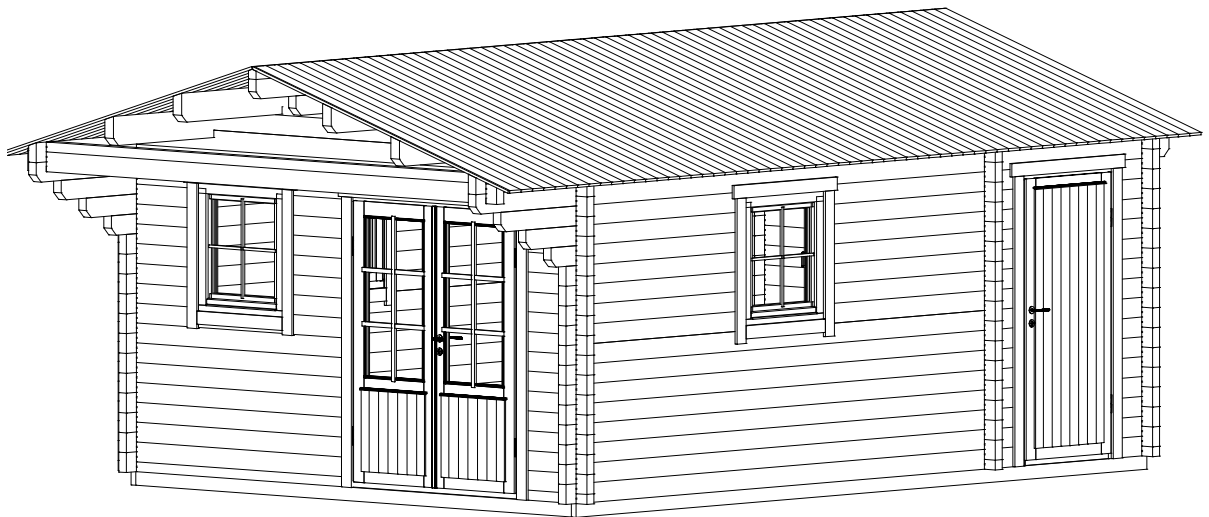

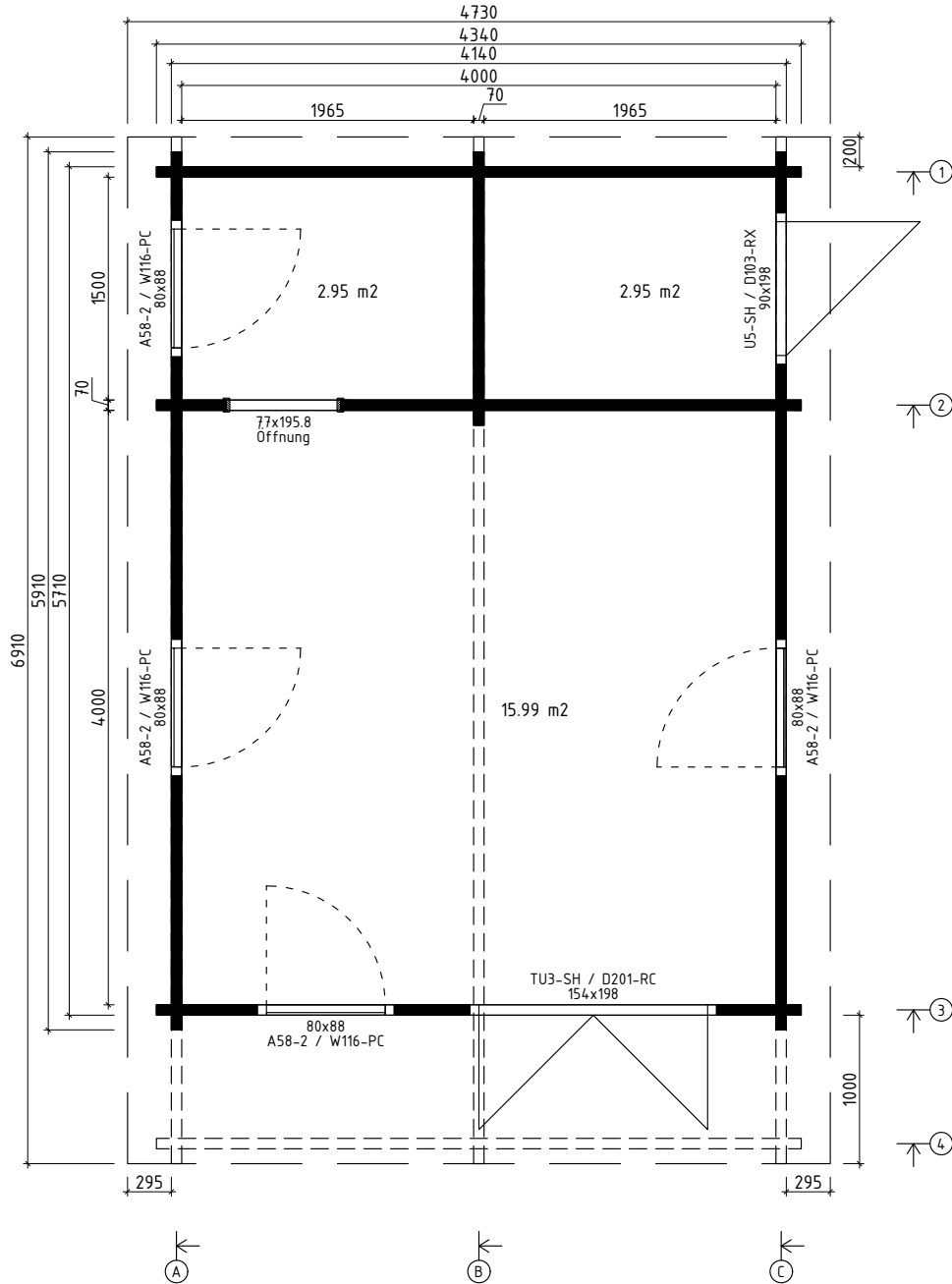







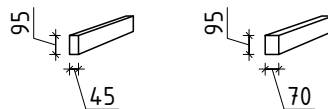
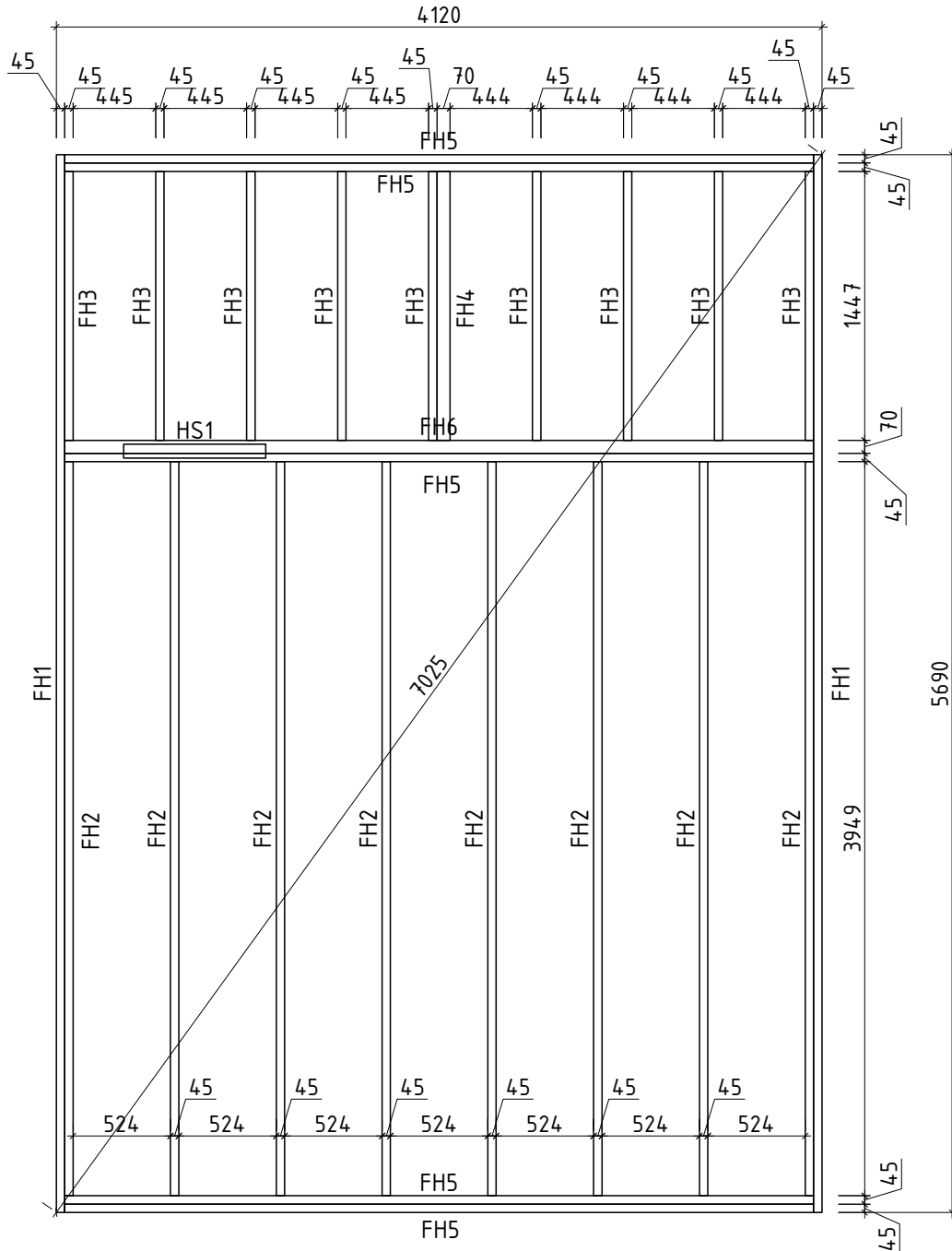

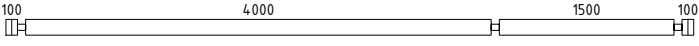
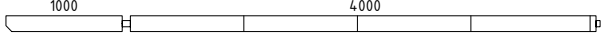

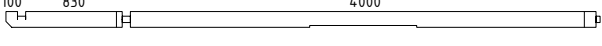
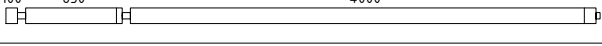
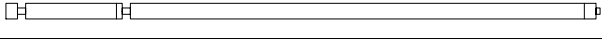
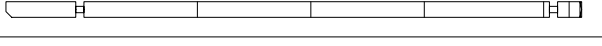

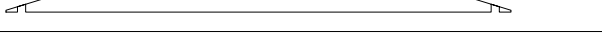
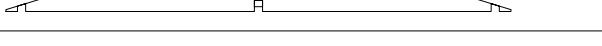

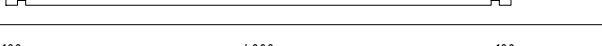

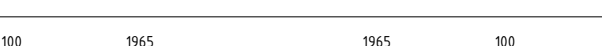

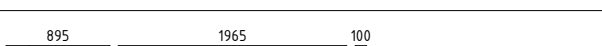

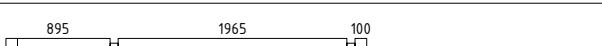

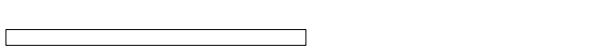
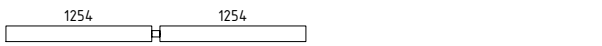



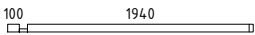
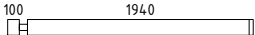
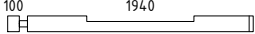
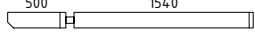
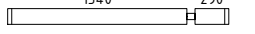
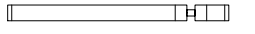

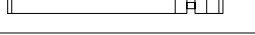
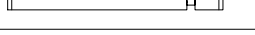

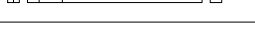
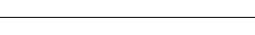

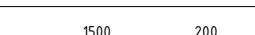
*Fenster und Türen sind mit Sprossen

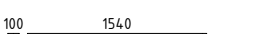

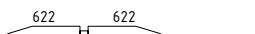















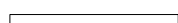



Q4 –Qualitätsklasse für Fenster und Türen

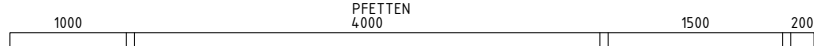
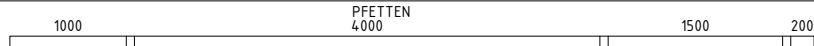

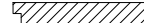
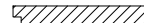













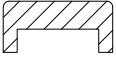
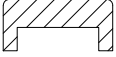



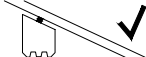

Wir empfehlen als Fundament für Ihr Gartenhaus eine vollflächig festgegründete, gepflasterte oder betonierte Fläche. Wahlweise ist auch ein Punkt- oder Streifenfundament möglich.

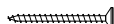

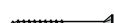







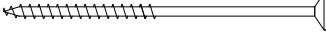



Pos		Stck	Profil (mm)	Länge (mm)
	Achtung! Die Giebelbohlen können teilweise schon vormontiert sein! Bitte beachten - diese erscheinen nicht ganz so wie in der Teileliste beschrieben.			
001		8	70x135	5910
002		1	70x135	5105
003		1	70x68	5105
004		2	70x135	5105
005		1	70x135	5105
006		1	70x135	5105
007		1	70x135	4948
008		8	70x135	4480
009		1	70x135	4340
010		2	70x135	4340
011		1	70x68	4340
012		2	70x135	4340
013		1	70x135	4340
014		17	70x135	4340
015		1	70x135	4340
016		1	70x68	4340
017		1	70x68	3100
018		7	70x135	3100
019		2	70x135	3100
020		5	70x135	3100
021		2	70x135	2577
022		1	70x135	2577
023		1	70x135	2577
024		2	70x135	2577
025		2	70x135	2360

Pos		Stck	Profil (mm)	Länge (mm)
026		1	70x68	2110
027		7	70x135	2110
028		1	70x135	2110
029		2	70x135	2110
030		6	70x135	1900
031		1	70x135	1900
032		2	70x135	1860
033		1	70x135	1850
034		6	70x135	1850
035		18	70x135	1840
036		1	70x135	1840
037		1	70x135	1805
038		1	70x135	1805
039		1	70x135	1805
040		1	70x68	1805
041		1	70x135	1805
042		1	70x135	1805
043		8	70x135	1710
044		1	70x135	1478
045		3	70x135	1314
046		3	70x124	889
047		6	70x135	680
048		1	70x68	570
049		14	70x135	570
050		6	70x135	510

Pos		Stck	Profil (mm)	Länge (mm)
051		1	70x68	470
052		7	70x135	470
053		2	70x135	470
054		5	70x135	470
055		7	70x135	460
056		6	70x127	419
057		15	70x135	410
058		6	70x49	162
FH6	FUNDAMENTHÖLZER (imprägniert) 	1	70x95	4030
FH4	FUNDAMENTHÖLZER (imprägniert) 	1	70x95	1447
FH1	FUNDAMENTHÖLZER (imprägniert) 	2	45x95	5690
FH5	FUNDAMENTHÖLZER (imprägniert) 	5	45x95	4030
FH2	FUNDAMENTHÖLZER (imprägniert) 	8	45x95	3949
FH3	FUNDAMENTHÖLZER (imprägniert) 	9	45x95	1447
HS1	HOLZSCHWELLE 	1	75x28	765
PF2	PFETTEN 4000 	2	80x200	6910
PF1	PFETTEN 4000 	2	80x200	6910
	DACHBRETTEN 	124+1	113x18	2470
	FUSSBODENBRETTEN 	36+1	113x28	3995
	FUSSBODENBRETTEN 	28	113x28	1960
	DECKENLEISTEN  ✓		15x28	43.0l fm
	FUSSBODENLEISTEN  ✓		14x55	30.0l fm
G02-1	GIEBELBRETTEN 18x120  16.9° ✓	4	18x120	2550
G01-1	GIEBELBRETTEN 18x95  16.9° ✓	4	18x95	2550
G06-1	GIEBELDECKLEISTEN 18x58  ✓	4	18x58	2550

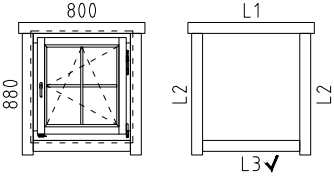
Pos			Stck	Profil (mm)	Länge (mm)
G08-1	GIEBELLEISTEN 18x58	 ✓	4	18x58	2550
T01-1	TRAUFBRETTER 18x95		4	18x95	3455
T06-1	TRAUFENLEISTEN 18x40	 ✓		18x40	14.0lfm
TL70-1	T-LEISTE 70		2	45x70	760
TL70-2	T-LEISTE 70		6	45x70	895
TL70-3	T-LEISTE 70		2	45x70	1908
TL70-4	T-LEISTE 70		2	45x70	1975
UP6-1	U-PROFIL 70	 ✓	1	44x94	890
UP6-2	U-PROFIL 70	 ✓	2	44x94	2020
GS	Giebelsegment		2		
SH	Schlaghölzer		3		
VS	VERBINDUNGSSTREIFEN für verbinden der Wandbohlen		6		
KP-1	DACHPAPPE	 ✓		7.1m-6st	43.0lfm
DBA ND-1	DICHTUNGSBAND (letzte Bohlenkranz Seitenwänder)	 ✓			14.0lfm
NG01	DACHPAPPNÄGEL 2.8x15		700		
NG04	NÄGEL 2.5x50 Dachbretter		992		
SR32	SCHRAUBEN 3.0x30 Deckleisten, Fussbodenteisten Traufenleisten 40x18		228		
SR37	SCHRAUBEN 3.5x45 Verbindungsstreifen Fenster- und Türleisten		24		
SR3547	SCHRAUBEN 3.5x45 C3 Fenster- und Türleisten		142		
SR3547	SCHRAUBEN 3.5x45 C3 Giebelbretter		48		
SR3547	SCHRAUBEN 3.5x45 C3 Giebelleisten, Giebeldeckleisten		48		
SR3547	SCHRAUBEN 3.5x45 C3 Giebelsegment		4		
SR3547	SCHRAUBEN 3.5x45 C3 Traufenbretter		28		
SR4257	SCHRAUBEN 4.2x55 C2 28mm Fussbodenbretter		428		
SR57	SCHRAUBEN 5.0x100 Fundamenthölzer		104		

Pos		Stck.	Profil (mm)	Länge (mm)
SR61	SCHRAUBEN 6.0x140 pos 010 	5		
ML1	Metallstange 	2	D10	1240
ML2	Metallstange 	2	D10	1040
ML3	Metallstange 	2	D10	430
ML4	Metallstange 	5	D10	360
KL1	Gewindestange M8 	4		2000
KL2	Gewindestange M8 	3		338
KL3	Gewindestange M8 	4		325
KV M UT M8	Mutter M8 	14		
KV S EIB M8X25	U-Scheibe M8 Ø25 	14		
KV MU TJ M8	Befestigungsmutter M8 	4		
	FENSTER Q4 W4-S70P-04C-08000880  <p>A58-2 / W116-PC</p> <p>L1 18x90 L=1040mm 2x L2 18x90 L=1000mm 4x L3 18x90 L=800mm 2x ✓</p>	4		
	TÜR Q4 D4-D70R-56C-15401980  <p>TU3-SH / D201-RC</p> <p>L1 18x90 L=1780mm 2x L2 18x90 L=1980mm 4x ✓</p> <p>DIN rechts</p>	1		

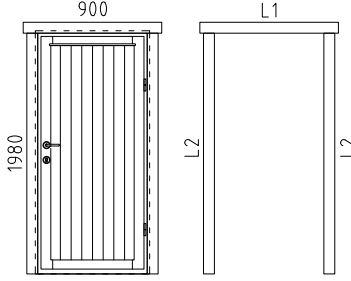
Pos		Stck.	Profil (mm)	Länge (mm)
	<p>TÜR Q4 D4-S70R-XX-09001980</p>  <p>U5-SH / D103-RX</p> <p>L1 18x90 L=1140mm 2x L2 18x90 L=1980mm 4x ✓</p> <p>DIN rechts</p>	1		
	<p>✓ - bitte selber anpassen (falls nötig!)</p>			

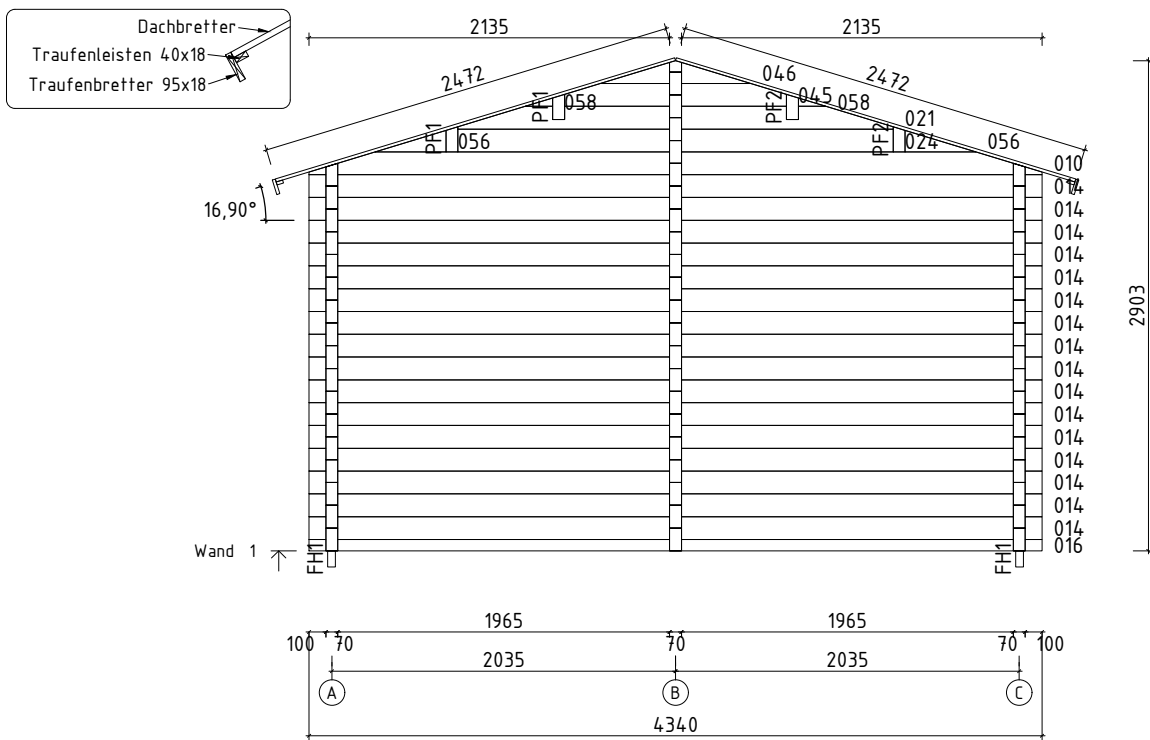

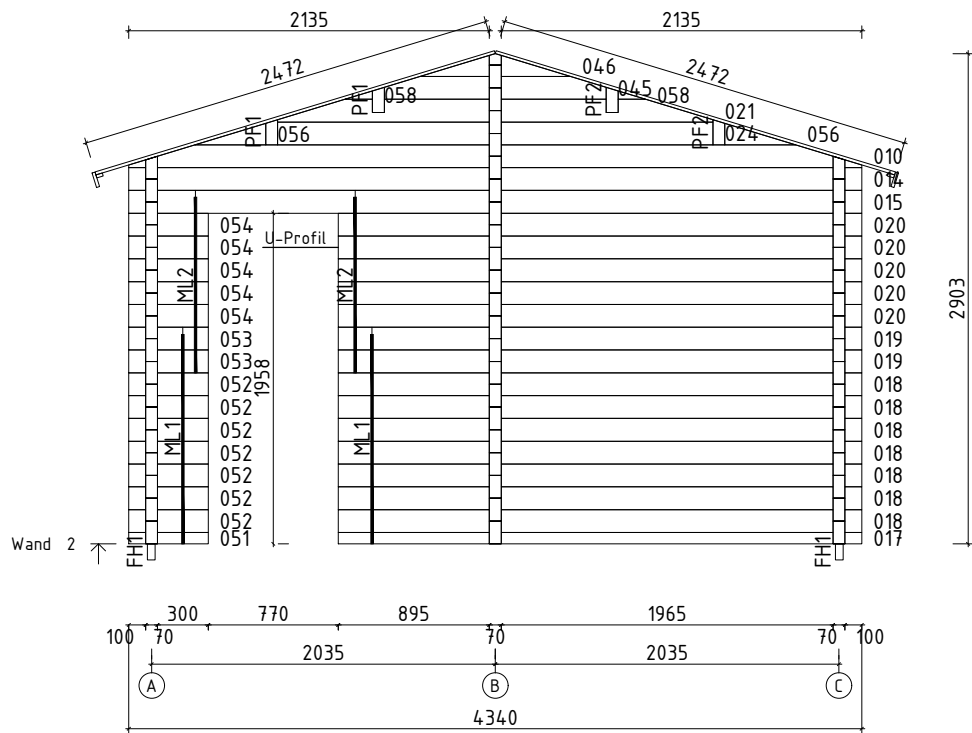

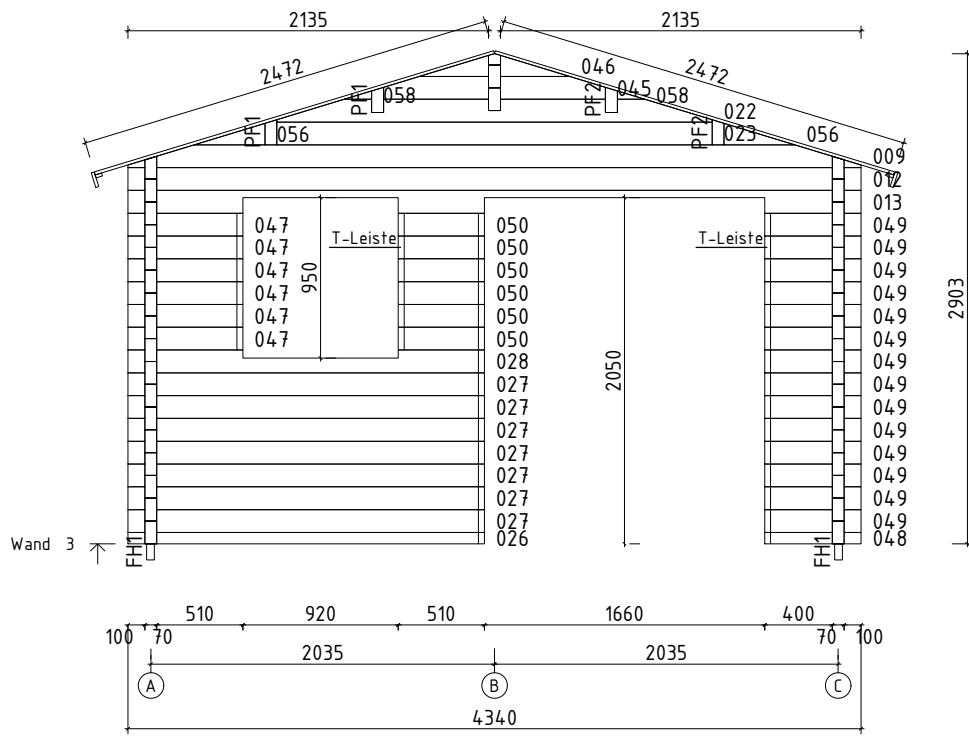

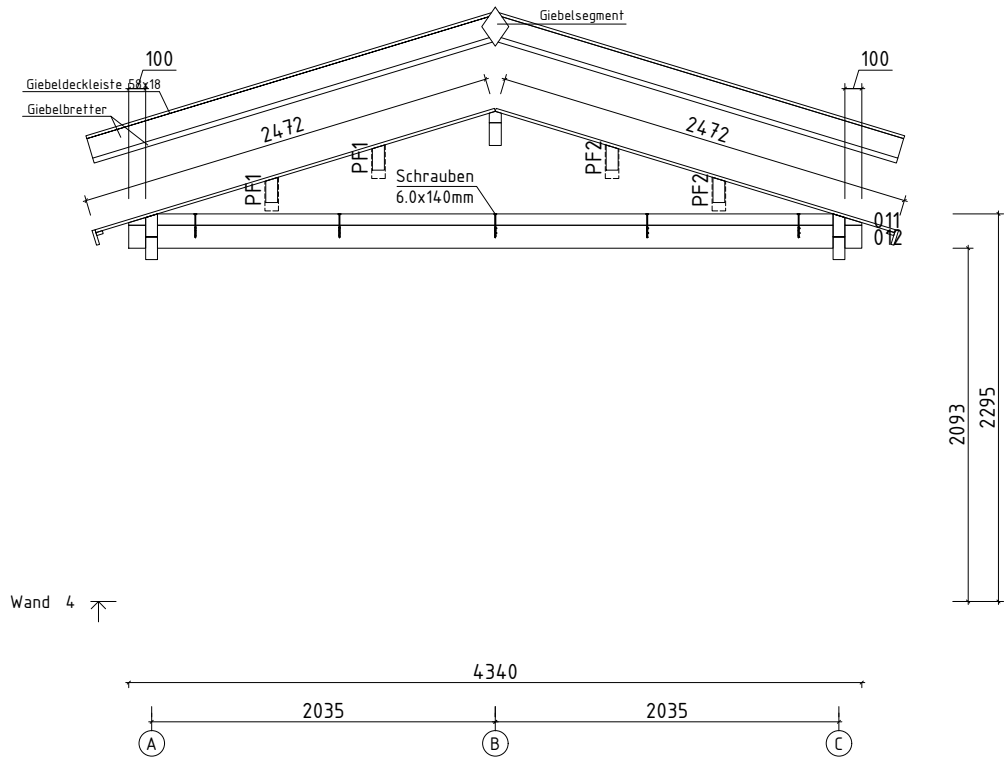

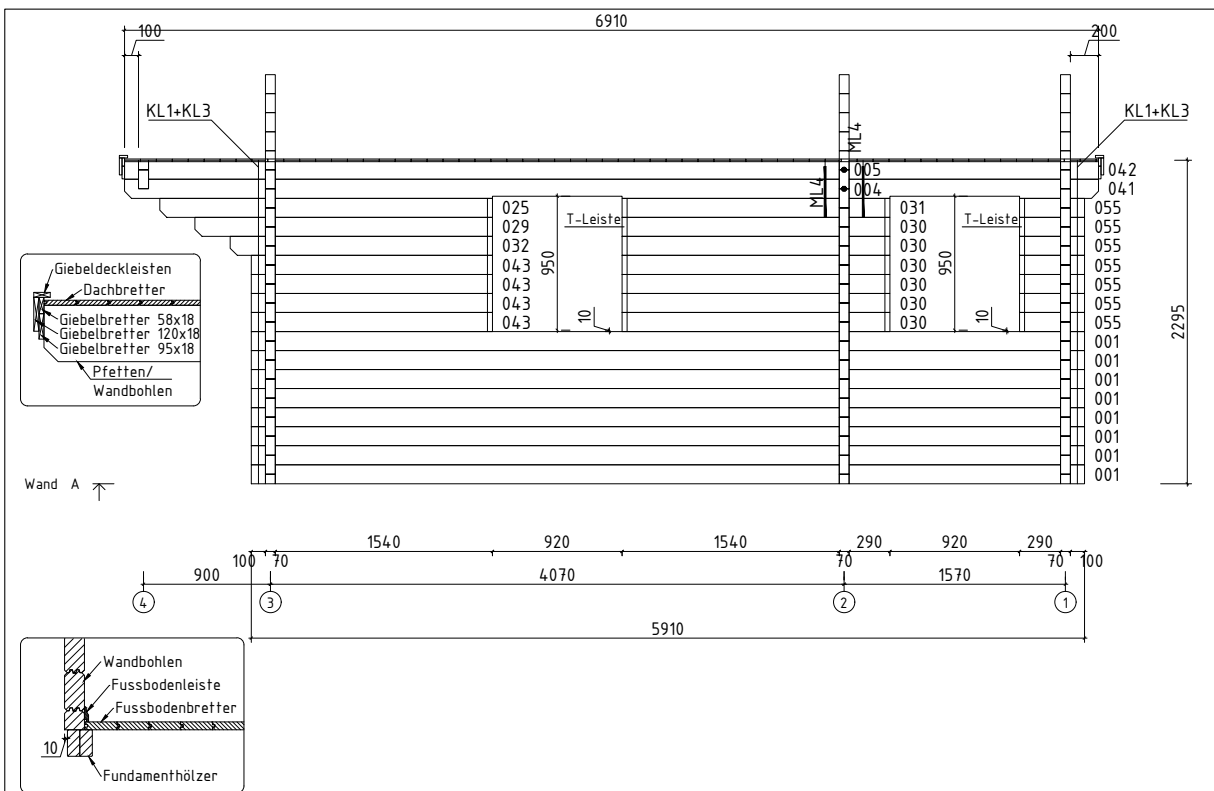

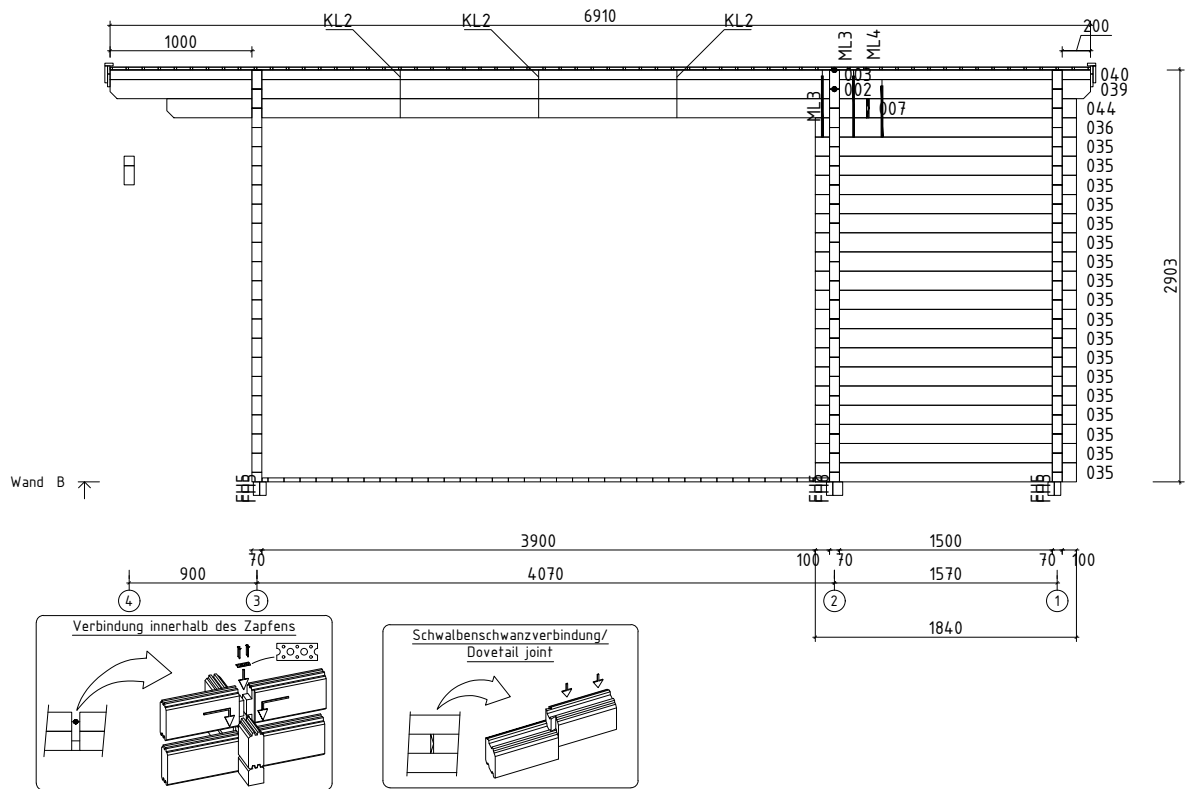

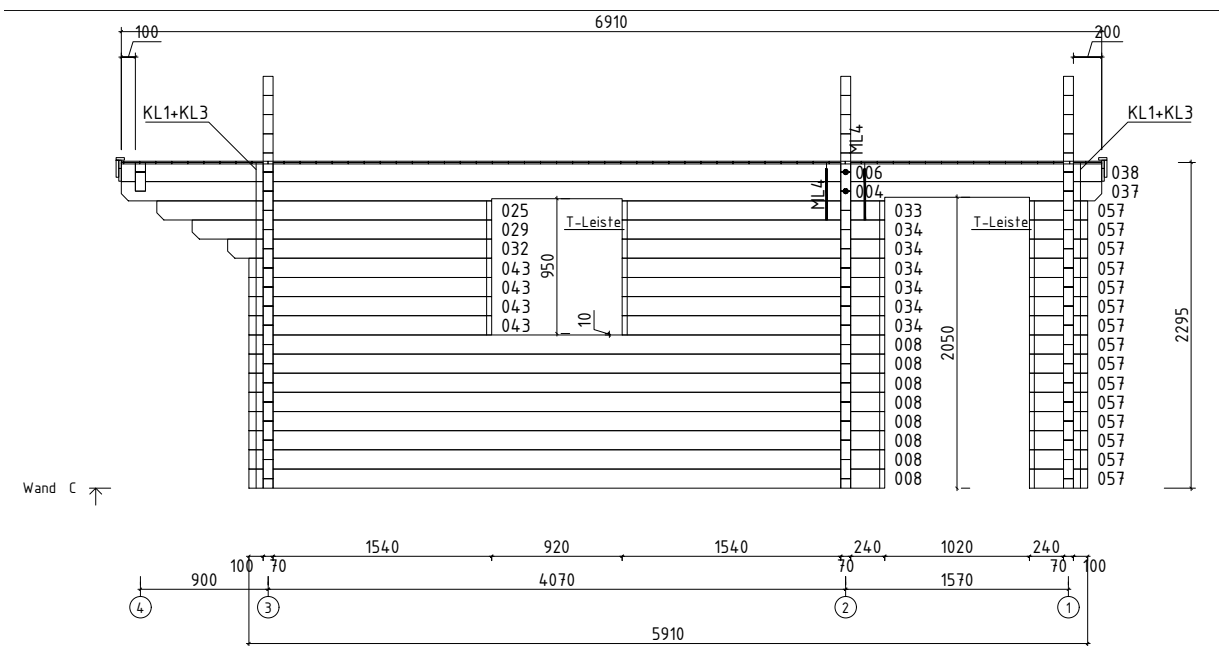

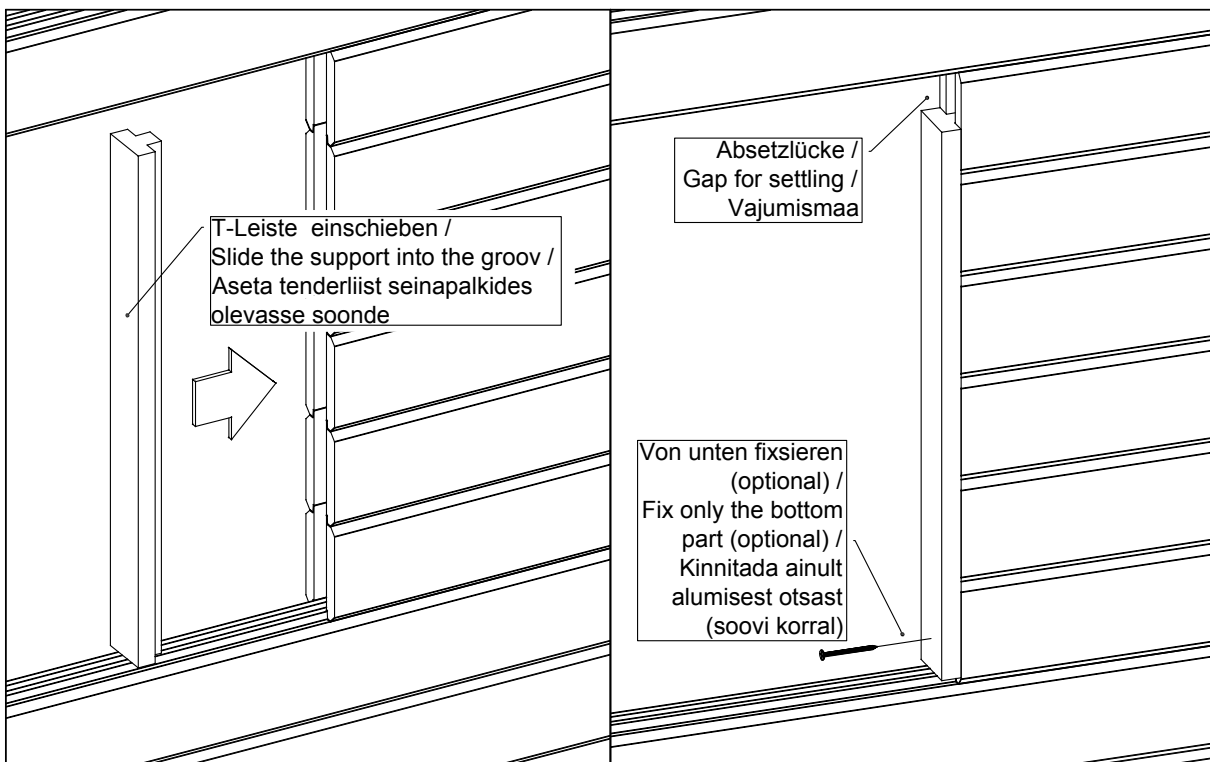

Q4

