

Technische Daten: Art.-Nr.: 660110

Wandaußenmaß: 335,6 x 335,6 cm

Bohlenstärke: 42 mm



Ibiza A mit zwei Zusatzfenster

Kontrolliert durch:

Empty box for signature or name.

Achtung: Alle angegebenen Maße sind ca.-Maße!

3D-Darstellung und Grundriss 660110

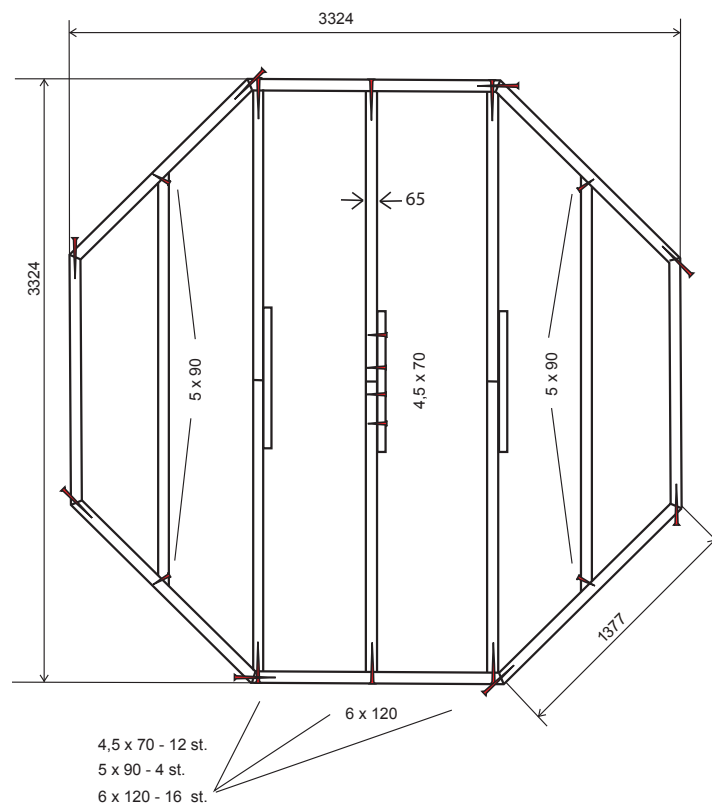

Fundamentpläne

660110





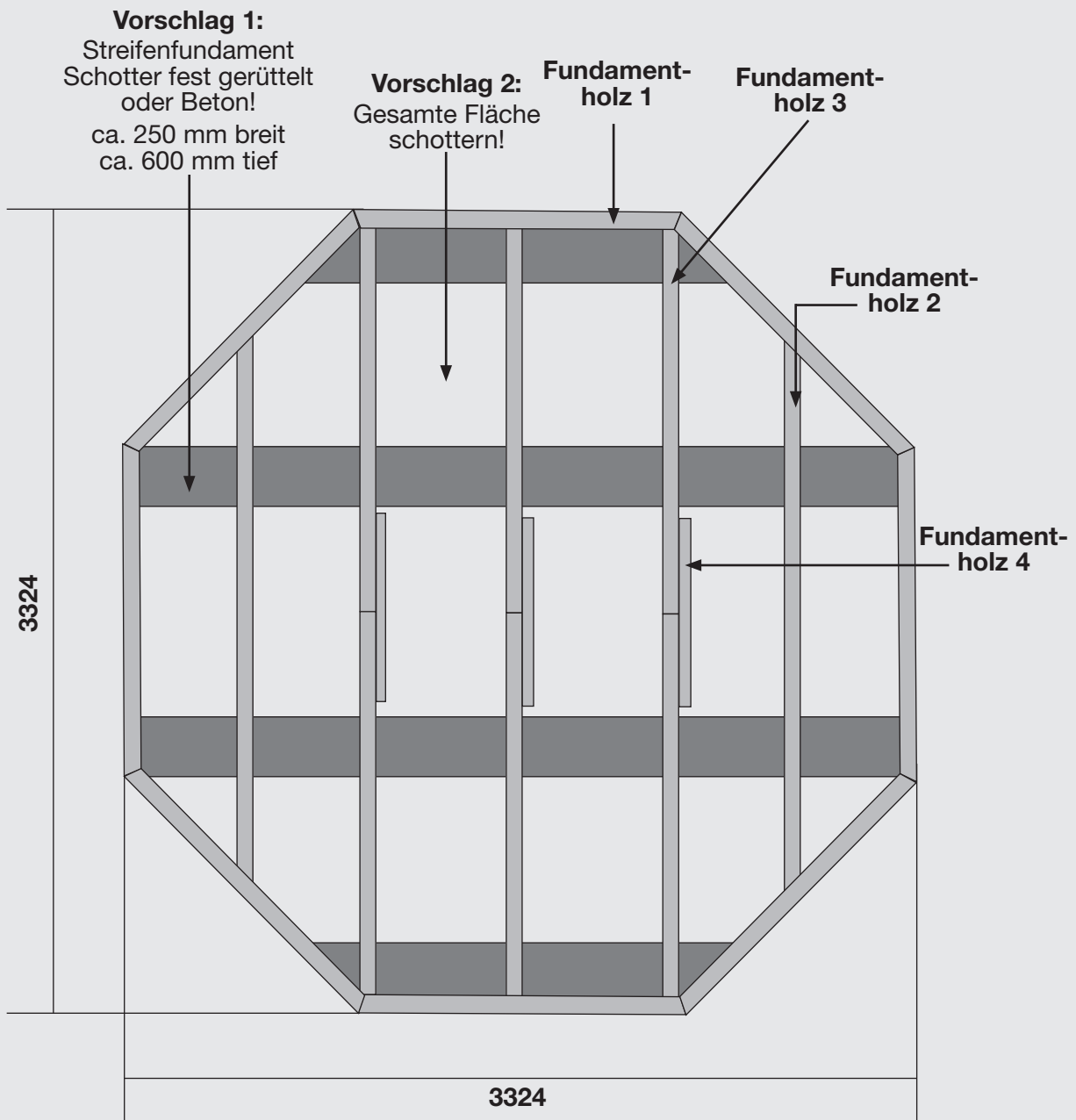





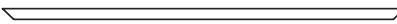
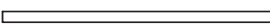



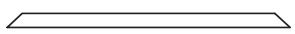
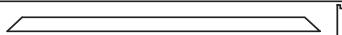

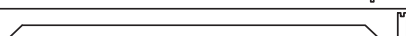
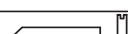
Dieser Fundamenplan ist ein unverbindlicher Vorschlag
und kann individuell verändert werden!

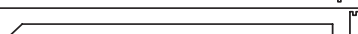
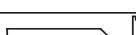
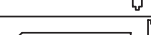
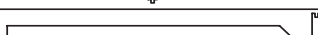
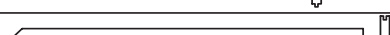
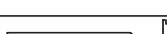
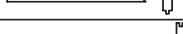
Haustyp	Anzahl der Fundamenthölzer (B x H x L)
Ibiza A	Fundamentholz 1: 8 (45 x 65 x 1377 mm) Fundamentholz 2: 2 (45 x 65 x 2321 mm) Fundamentholz 3: 6 (45 x 65 x 1597 mm) Fundamentholz 4: 3 (45 x 45 x 600 mm)

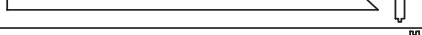
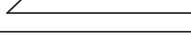
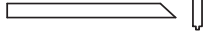

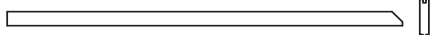
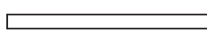
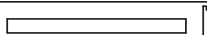

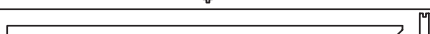
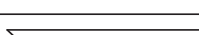

Teilleiste 1

660110

Nr		profile (mm)	pcs.
1	Fundament 	45x65x1377	8
2	Fundament 	45x65x2321	2
3	Fundament 	45x65x1597	6
4	Fundament 	45x45x600	3
5	Fussbodenbrett 	21x90	
5.1		21x50x1458	1
5.2		21x90x1632	1
5.3		21x90x1805	1
5.4		21x90x1981	1
5.5		21x90x2154	1
5.6		21x90x537	1
5.6.1		21x90x1791	1
5.7		21x90x1878	1
5.7.1		21x90x625	1
5.8		21x90x713	1
5.8.1		21x90x1965	1
5.9		21x90x2054	1
5.9.1		21x90x799	1
5.10		21x90x877	1
5.10.1		21x90x2140	1
5.11		21x90x2225	1
5.11.1		21x90x972	1
5.12		21x90x1032	1
5.12.1		21x90x2282	1
5.13		21x90x2282	15
5.13.1		21x90x1032	15
5.14		21x90x1032	1
5.14.1		21x90x2282	1
5.15		21x90x2225	1
5.15.1		21x90x972	1
5.16		21x90x887	1

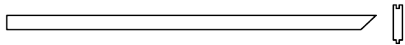
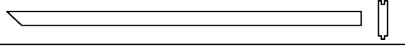
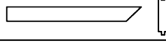
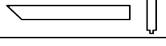
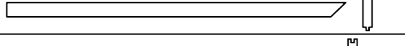
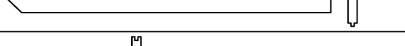
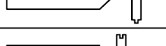
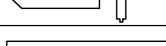
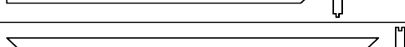
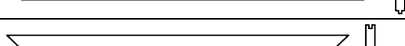
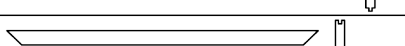
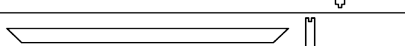
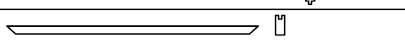
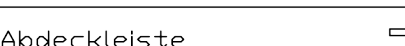
Teileliste 2

660110

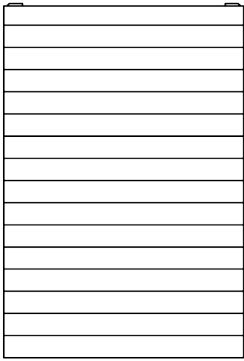
Nr		profile (mm)	pcs.
5.16.1		21x90x2140	1
5.17		21x90x2054	1
5.17.1		21x90x779	1
5.18		21x90x713	1
5.18.1		16x80x1965	1
5.19		16x90x1878	1
5.19.1		16x90x625	1
5.20		21x90x537	1
5.20.1		21x90x1791	1
5.21		21x90x2154	1
5.22		21x90x1981	1
5.23		21x90x1805	1
5.24		21x90x1632	1
5.25		21x90x1458	1
6	Abdeckleiste 	16x80x2146	16
7	Dachstützleiste 	16x90x1247	8
8	Dachblende 	16x90x1670	8
9	Dachelement	62x1635x2336	8
10	<div style="display: flex; align-items: center; justify-content: center;"> <div style="margin-right: 20px;">Wandelement</div>  <div style="margin-left: 20px;">77x1390x2190</div> </div>	77x1390x2190	5

Teilleiste 3

660110

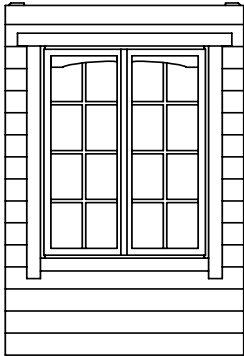
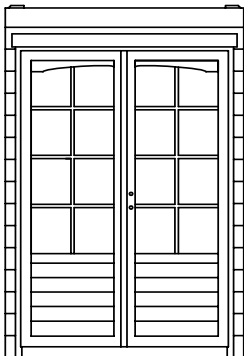
Nr		profile (mm)	pcs.
12	Fensterelement 	77x1390x2190	2
13	Türelement 	77x1390x2190	1
14	Zylinderschloss		1
15	Türbeschlag		1
16	Fenstergriff		4
17	Fensterfeststeller		2
18	Schraube	3x25	48
19	Schraube	3x35	176
20	Schraube	4,5x70	12
21	Schraube	5x90	92
22	Schraube	6x120	14
23	Nagel	2,1x50	350
24	Dachpappnagel	2,5x20	450
25	Schraube	4,8x25	4

Wandpläne 660110

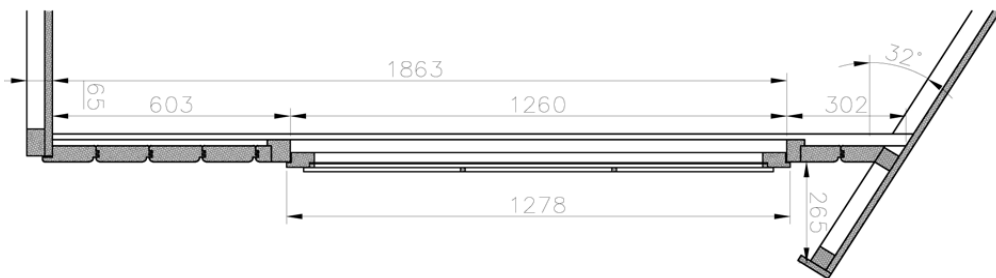
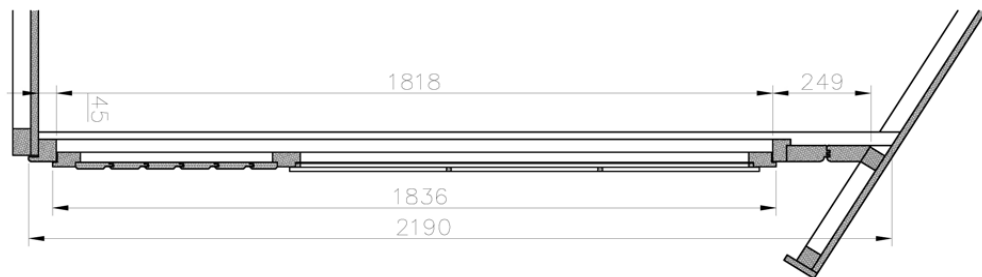
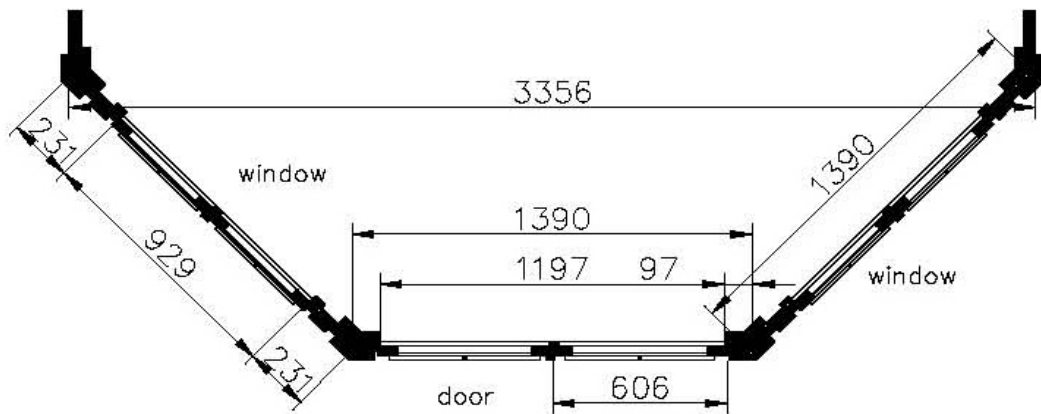

Fußbodenverlegeplan 660110

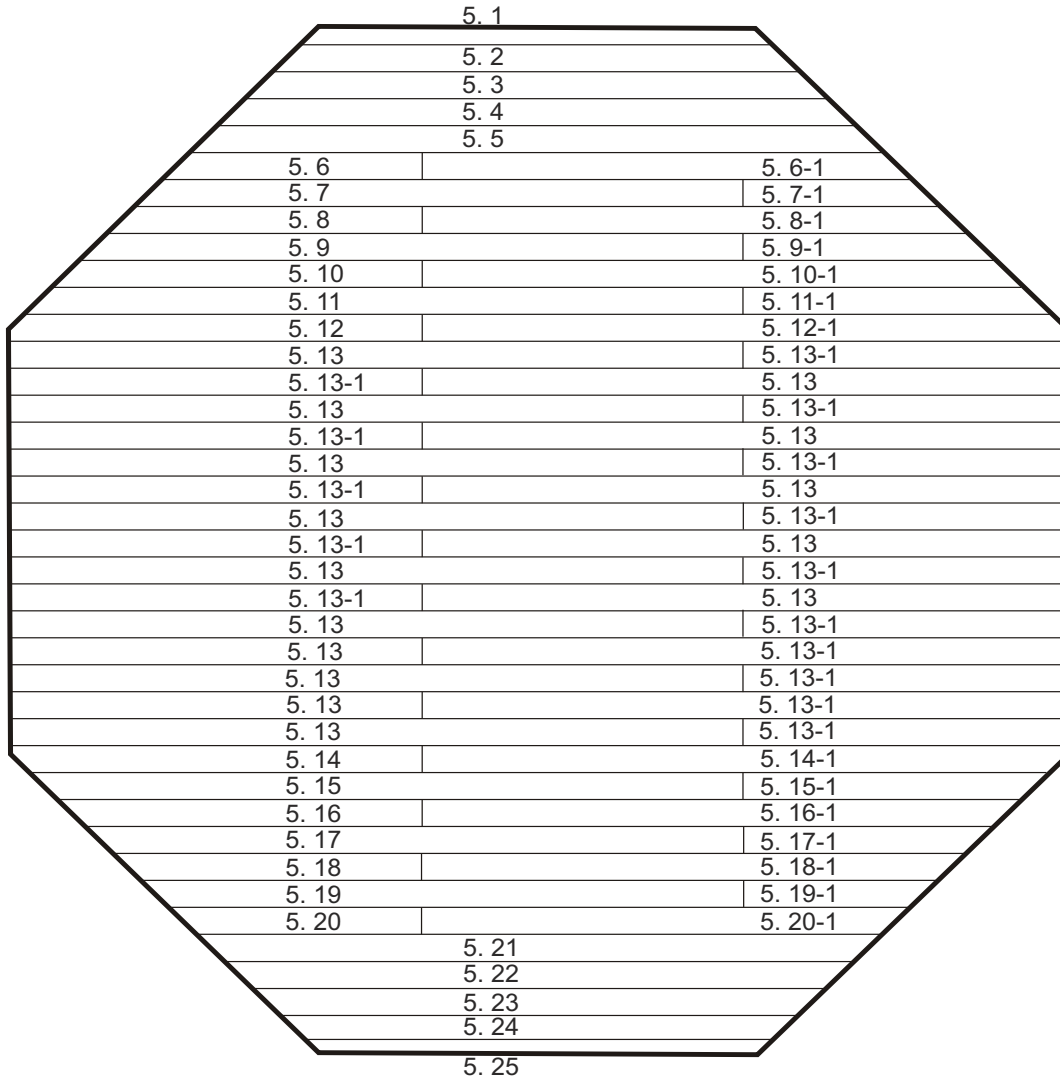

5.1	1458x50	5.10	887	5.16.1	2140
5.2	1632	5.10.1	2140	5.17	2054
5.3	1805	5.11	2225	5.17.1	779
5.4	1981	5.11.1	972	5.18	713
5.5	2154	5.12	1032	5.18.1	1965
5.6	537	5.12.1	2282	5.19	1878
5.6.1	791	5.13	2282	5.19.1	625
5.7	1878	5.13.1	1032	5.20	537
5.7.1	625	5.14	1032	5.20.1	1791
5.8	713	5.14.1	2282	5.21	2154
5.8.1	1965	5.15	2225	5.22	1981
5.9	2054	5.15.1	972	5.23	1805
5.9.1	799	5.16	887	5.24	1632
				5.25	1458x50